

# SUSSEX RANGE

by JIS EUROPE

HEATED TOWEL RAILS

EST 1997

100% STAINLESS STEEL

At JIS we are proud of our company. We are the original stainless steel towel rail company. We decided to produce our rails from stainless steel because it was the environmental and durable choice. This was some 25 years ago, long before they were the bywords and marketing spin of the day. We source our rails ethically, always have and always will. Our customers and staff are the most important factors in our business. We endeavour to always offer the best customer service, be it on the phone, our 25 year guarantee or the variety and practicability of our rails. We are known throughout the industry for these standards. We only ever strive to be better and better at our job. As I said, we are proud of our company, we believe you will be proud of our product.

Enjoy the collection,

Richard Thelwell  
Managing Director



## LADDER RAILS

Ouse - Flat front ladder rail.....	6
Steyning - Flat front ladder rail .....	9
Ashdown - Flat front ladder rail .....	11
Beacon - Flat front ladder rail.....	12
Newick - Flat front rail .....	15
Cinder - Large gap ladder rail .....	16
Rusper - Large gap ladder rail .....	16
Pevensy - Large gap ladder rail.....	19
Lindfield - Large gap ladder rail .....	19
Ardingly - Large gap ladder rail .....	20
Lewes - Large gap ladder rail.....	22
Buxted - Flat front ladder rail .....	25
Coombe - High output ladder rail .....	25
Ansty - High output ladder rail .....	25
Adur - Curved front ladder rail.....	27
Camber - Curved front ladder rail.....	28

## DESIGNER RAILS

Findon - Flat front ladder rail with protruding curved bars.....	33
Alfriston - Flat front ladder rail within frame .....	34
Fletching - Traditional rail.....	37
Fletching Floor to Wall - Floor mounted traditional rail.....	38
Brunswick - Square ladder rail .....	40
Hickstead - Side arm projection with square profile.....	44
Goodwood - Side arm projection with oval profile.....	47
Rye *Charity initiative* - Leaning ladder rail .....	49
Midhurst - Side projection ladder rail .....	51
Newhaven - Shelf towel rail.....	52

## FEATURE RAILS

Mayfield - Large tubular rail.....	56
Arun - Flat panel rail .....	58
Hove - Small tubular rail.....	62

## BLACK RANGE

Opening Statement .....	67
Ouse - Powder coated ladder rail .....	68
Ashdown - Powder coated ladder rail .....	70
Beacon - Powder coated ladder rail .....	72
Newick - Powder coated ladder rail.....	74
Rusper and Pevensy - Powder coated ladder rail.....	76
Ardingly and Lindfield - Powder coated ladder rail.....	78
Alfriston - Powder coated ladder rail within frame.....	80
Rye *Charity Initiative* - Powder coated leaning ladder rail .....	82

## ACCESSORIES

Black Accessories .....	84
Valves - Pipes from Floor .....	85
Valves - Pipes from Wall .....	86
Dual Fuel Valves.....	88
Elements.....	88
Dual Fuel Kits .....	89
Mixed Valves.....	89
Electric Only Towel Rails.....	90
Brackets & Accessories.....	91

Technical Sheet.....	94
----------------------	----



Lindfield Ladder Rail

# LADDER RAILS

# OUSE

Available in Central Heating, Electric & Dual Fuel

Additional Shelf Hanger Accessory available.

100% STAINLESS STEEL

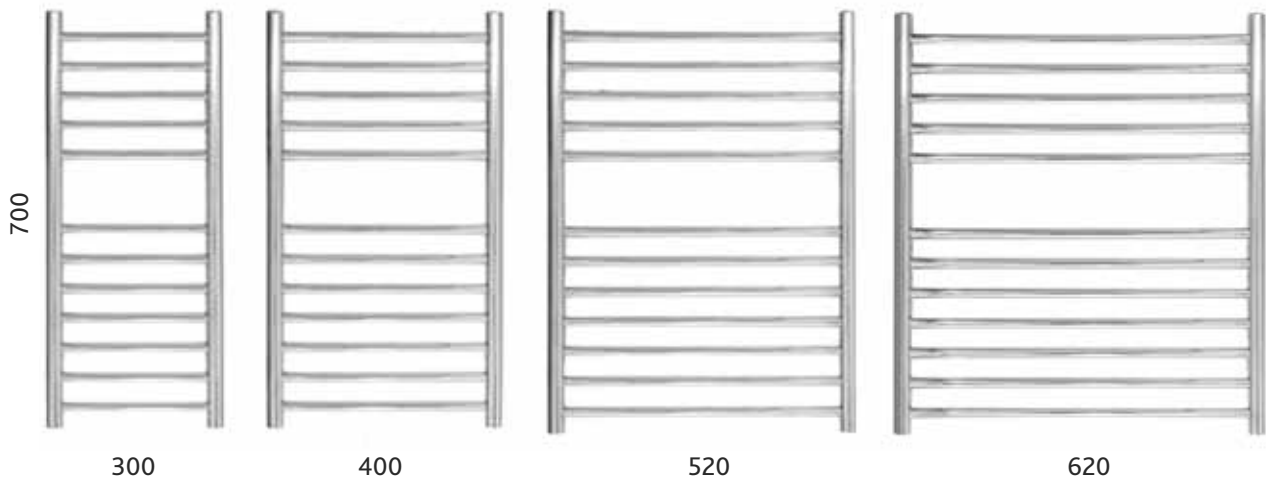

Model	Dimensions	BTU	Watts	RRP ex VAT
Ouse 300	700 x 300mm	1068	313	£205.50
Ouse 400	700 x 400mm	1380	404	£214.95
Ouse 520	700 x 520mm	1500	440	£222.50
Ouse 620	700 x 620mm	1648	483	£259.50

- The above prices are based on central heating format.
- Available in central heating, electric and dual fuel formats.
- For pipe centres, subtract 30mm from width. For dual fuel, pipe centres may differ.
- Satin finish is available, please add 30% to the price shown.
- Standard brackets are included with the towel rail unless otherwise stated.
- Standard (85mm) & short (60mm) brackets are available. Adjustable brackets are £29.95 extra when purchased with the rail. They are £79.90 when purchased separately. Please see page 92 for further details.
- The Sussex Range of towel rails are also available in electric only format. Electric formats start from an additional £89.95 with adjustable options also available. Please see page 90 for more details.
- Please see page 85, 86 and 87 for our valves.
- Additional shelf hanger accessory is available. Please see page 91 for further details.

25 YEAR GUARANTEE







# STEYNING

Available in Central Heating, Electric & Dual Fuel

Additional Shelf Hanger Accessory available.

100% STAINLESS STEEL

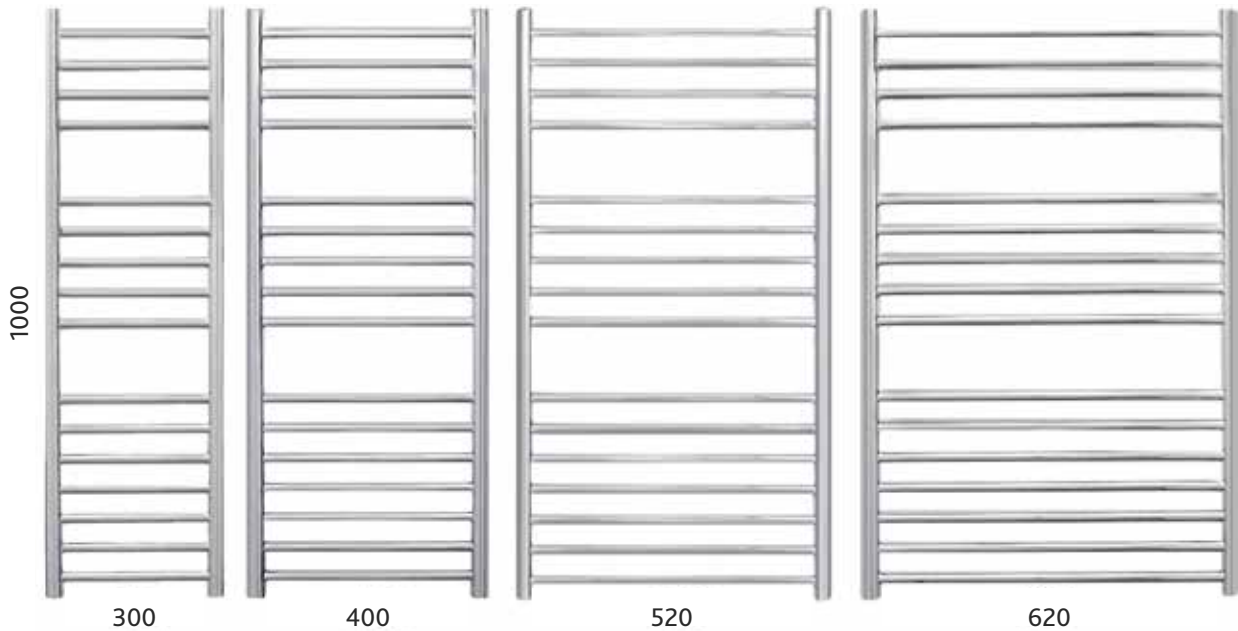

Model	Dimensions	BTU	Watts	RRP ex VAT
SteYning 300	1000 x 300mm	1517	445	£248.50
SteYning 400	1000 x 400mm	1806	529	£258.95
SteYning 520	1000 x 520mm	1968	576	£269.95
SteYning 620	1000 x 620mm	2108	618	£318.50

- The above prices are based on central heating format.
- Available in central heating, electric and dual fuel formats.
- For pipe centres, subtract 30mm from width. For dual fuel, pipe centres may differ.
- Satin finish is available, please add 30% to the price shown.
- Standard brackets are included with the towel rail unless otherwise stated.
- Standard (85mm) & short (60mm) brackets are available. Adjustable brackets are £29.95 extra when purchased with the rail. They are £79.90 when purchased separately. Please see page 92 for further details.
- The Sussex Range of towel rails are also available in electric only format. Electric formats start from an additional £89.95 with adjustable options also available. Please see page 90 for more details.
- Please see page 85, 86 and 87 for our valves.
- Additional shelf hanger accessory is available. Please see page 91 for further details.

25 YEAR GUARANTEE



Ashdown 520

# ASHDOWN

Available in Central Heating, Electric & Dual Fuel

Additional Shelf Hanger Accessory available.

100% STAINLESS STEEL

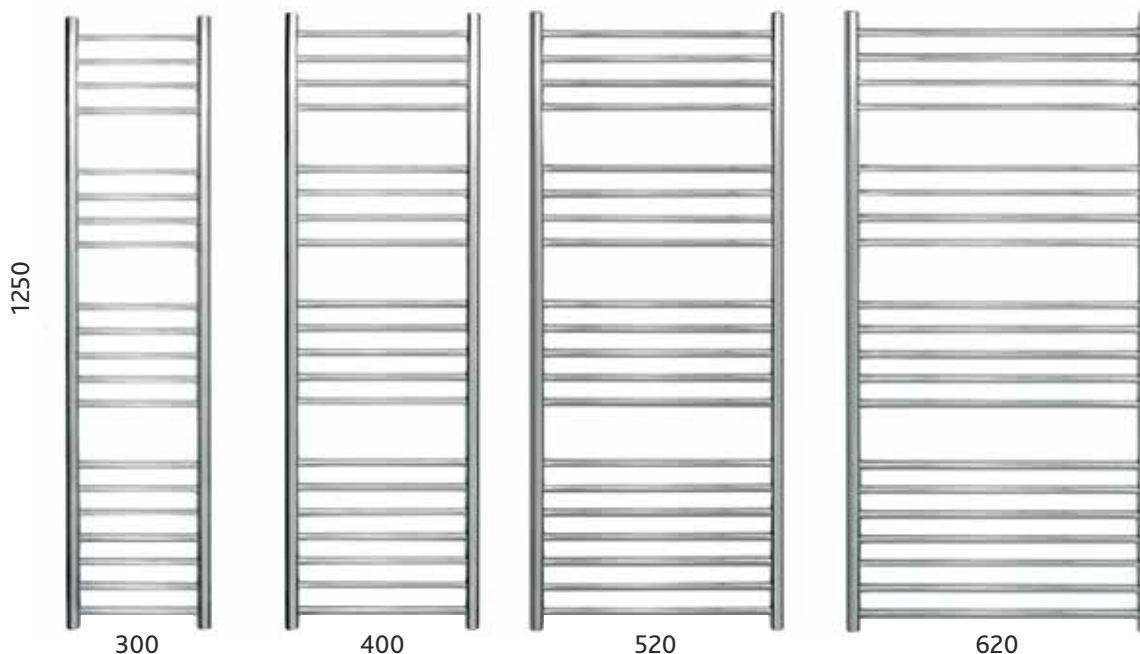

Model	Dimensions	BTU	Watts	RRP ex VAT
Ashdown 300	1250 x 300mm	2106	617	£291.95
Ashdown 400	1250 x 400mm	2368	694	£302.50
Ashdown 520	1250 x 520mm	2500	733	£323.95
Ashdown 620	1250 x 620mm	2726	799	£377.95

- The above prices are based on central heating format.
- Available in central heating, electric and dual fuel formats.
- For pipe centres, subtract 30mm from width. For dual fuel, pipe centres may differ.
- Satin finish is available, please add 30% to the price shown.
- Standard brackets are included with the towel rail unless otherwise stated.
- Standard (85mm) & short (60mm) brackets are available. Adjustable brackets are £29.95 extra when purchased with the rail. They are £79.90 when purchased separately. Please see page 92 for further details.
- The Sussex Range of towel rails are also available in electric only format. Electric formats start from an additional £89.95 with adjustable options also available. Please see page 90 for more details.
- Please see page 85, 86 and 87 for our valves.
- Additional shelf hanger accessory is available. Please see page 91 for further details.

25 YEAR GUARANTEE

# BEACON

Available in Central Heating, Electric & Dual Fuel

Additional Shelf Hanger Accessory available.

100% STAINLESS STEEL

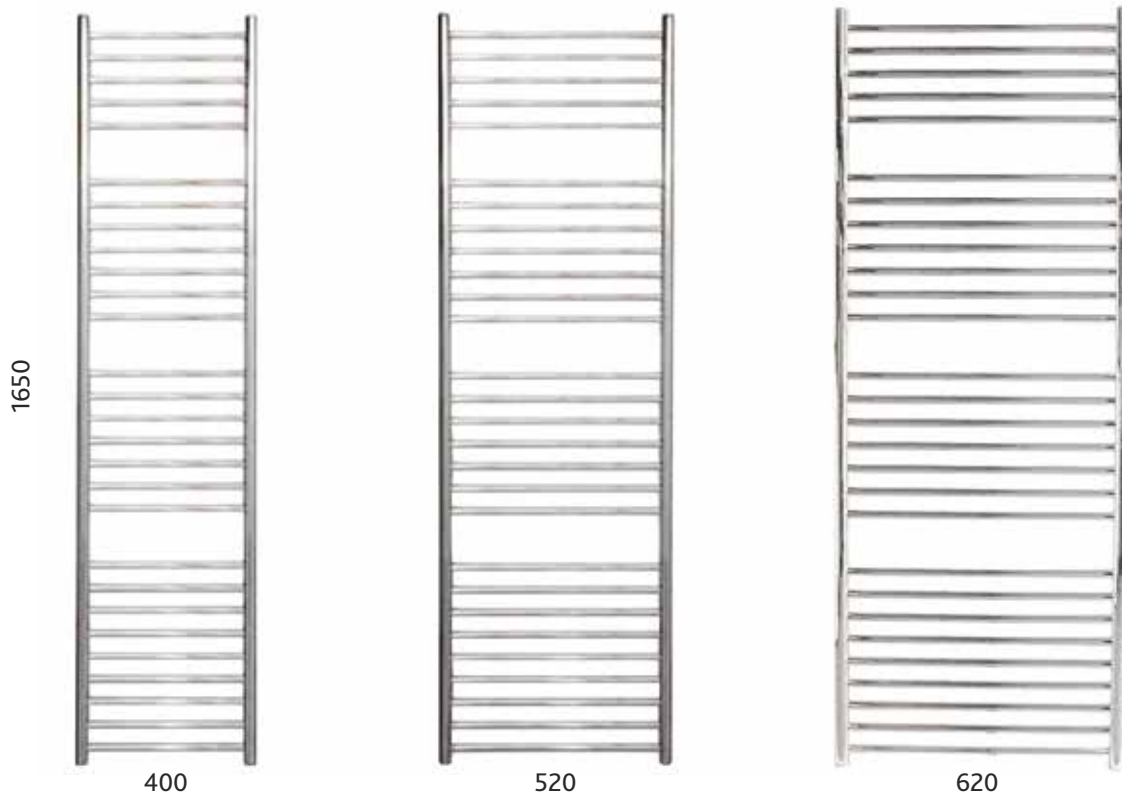

Model	Dimensions	BTU	Watts	RRP ex VAT
Beacon 400	1650 x 400mm	2709	794	£529.50
Beacon 520	1650 x 520mm	2932	859	£583.50
Beacon 620	1650 x 620mm	3129	917	£637.50

- The above prices are based on central heating format.
- Available in central heating, electric and dual fuel formats.
- For pipe centres, subtract 30mm from width. For dual fuel, pipe centres may differ.
- Satin finish is available, please add 30% to the price shown.
- Standard brackets are included with the towel rail unless otherwise stated.
- Standard (85mm) & short (60mm) brackets are available. Adjustable brackets are £29.95 extra when purchased with the rail. They are £79.90 when purchased separately. Please see page 92 for further details.
- The Sussex Range of towel rails are also available in electric only format. Electric formats start from an additional £89.95 with adjustable options also available. Please see page 90 for more details.
- Please see page 85, 86 and 87 for our valves.
- Additional shelf hanger accessory is available. Please see page 91 for further details.

25 YEAR GUARANTEE







# NEWICK

Available in Central Heating, Electric & Dual Fuel

100% STAINLESS STEEL

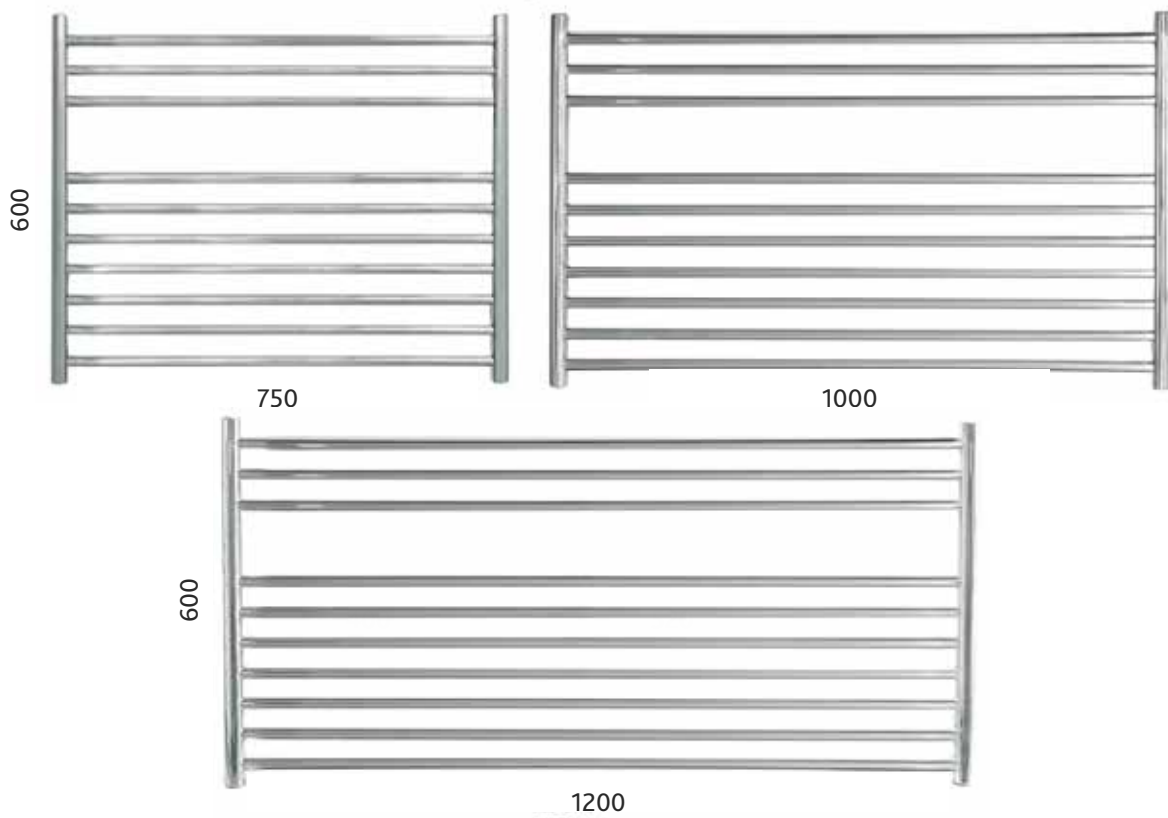

Model	Dimensions	BTU	Watts	RRP ex VAT
Newick 750	600 x 750mm	1676	491	£266.95
Newick 1000	600 x 1000mm	1885	552	£300.50
Newick 1200	600 x 1200mm	2079	609	£349.95

- The above prices are based on central heating format.
- Available in central heating, electric and dual fuel formats.
- For pipe centres, subtract 30mm from width. For dual fuel, pipe centres may differ.
- Satin finish is available, please add 30% to the price shown.
- Standard brackets are included with the towel rail unless otherwise stated.
- Standard (85mm) & short (60mm) brackets are available. Adjustable brackets are £29.95 extra when purchased with the rail. They are £79.90 when purchased separately. Please see page 92 for further details.
- The Sussex Range of towel rails are also available in electric only format. Electric formats start from an additional £89.95 with adjustable options also available. Please see page 90 for more details.
- Please see page 85, 86 and 87 for our valves.

25 YEAR GUARANTEE

# CINDER & RUSPER

Available in Central Heating, Electric & Dual Fuel

100% STAINLESS STEEL

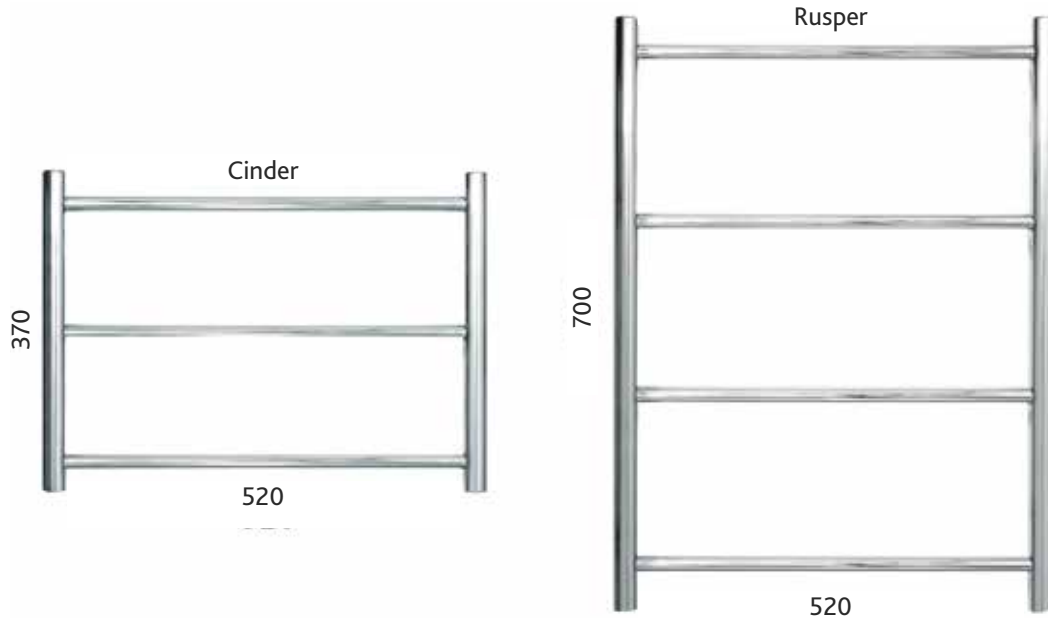

Model	Dimensions	BTU	Watts	RRP ex VAT
Cinder	370 x 520mm	410	120	£157.95
Rusper	700 x 520mm	740	217	£194.50

- The above prices are based on central heating format.
- Available in central heating, electric and dual fuel formats.
- For pipe centres, subtract 30mm from width. For dual fuel, pipe centres may differ.
- Satin finish is available, please add 30% to the price shown.
- Standard brackets are included with the towel rail unless otherwise stated.
- Standard (85mm) & short (60mm) brackets are available. Adjustable brackets are £29.95 extra when purchased with the rail. They are £79.90 when purchased separately. Please see page 92 for further details.
- The Sussex Range of towel rails are also available in electric only format. Electric formats start from an additional £89.95 with adjustable options also available. Please see page 90 for more details.
- Please see page 85, 86 and 87 for our valves.

25 YEAR GUARANTEE





# PEVENSEY & LINDFIELD

Available in Central Heating, Electric & Dual Fuel

100% STAINLESS STEEL

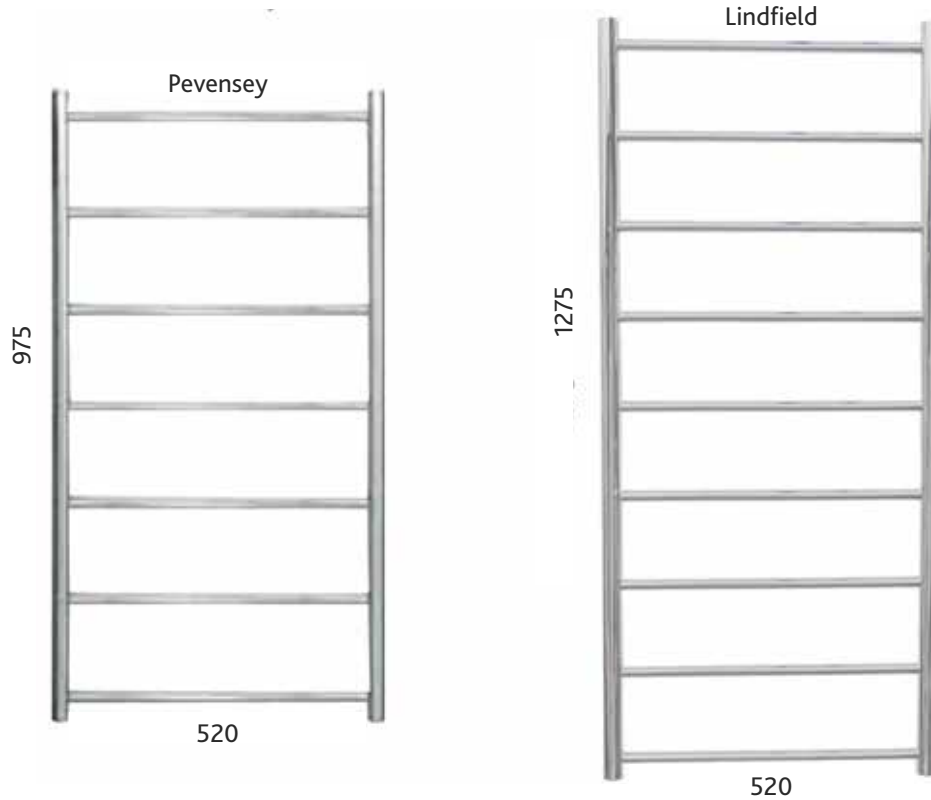

Model	Dimensions	BTU	Watts	RRP ex VAT
Pevensey	975 x 520mm	1381	405	£267.95
Lindfield	1275 x 520mm	1726	506	£317.95

- The above prices are based on central heating format.
- Available in central heating, electric and dual fuel formats.
- For pipe centres, subtract 30mm from width. For dual fuel, pipe centres may differ.
- Satin finish is available, please add 30% to the price shown.
- Standard brackets are included with the towel rail unless otherwise stated.
- Standard (85mm) & short (60mm) brackets are available. Adjustable brackets are £29.95 extra when purchased with the rail. They are £79.90 when purchased separately. Please see page 92 for further details.
- The Sussex Range of towel rails are also available in electric only format. Electric formats start from an additional £89.95 with adjustable options also available. Please see page 90 for more details.
- Please see page 85, 86 and 87 for our valves.

25 YEAR GUARANTEE

# ARDINGLY

Available in Central Heating, Electric & Dual Fuel

100% STAINLESS STEEL

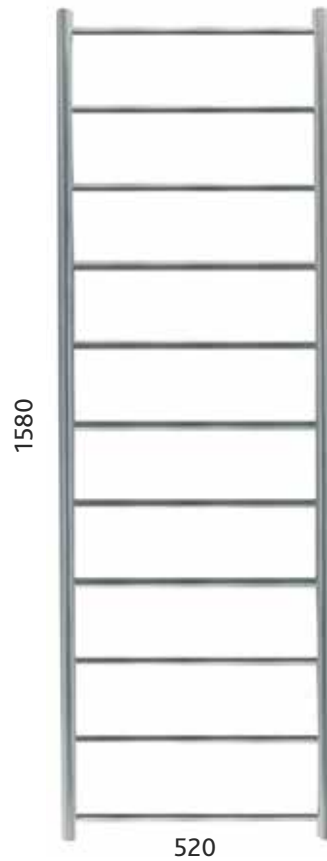

Model	Dimensions	BTU	Watts	RRP ex VAT
Ardingly	1580 x 520mm	2114	617	£388.95

- The above prices are based on central heating format.
- Available in central heating, electric and dual fuel formats.
- For pipe centres, subtract 30mm from width. For dual fuel, pipe centres may differ.
- Satin finish is available, please add 30% to the price shown.
- Standard brackets are included with the towel rail unless otherwise stated.
- Standard (85mm) & short (60mm) brackets are available. Adjustable brackets are £29.95 extra when purchased with the rail. They are £79.90 when purchased separately. Please see page 92 for further details.
- The Sussex Range of towel rails are also available in electric only format. Electric formats start from an additional £89.95 with adjustable options also available. Please see page 90 for more details.
- Please see page 85, 86 and 87 for our valves.

25 YEAR GUARANTEE



# LEWES

Available in Central Heating, Electric & Dual Fuel

100% STAINLESS STEEL

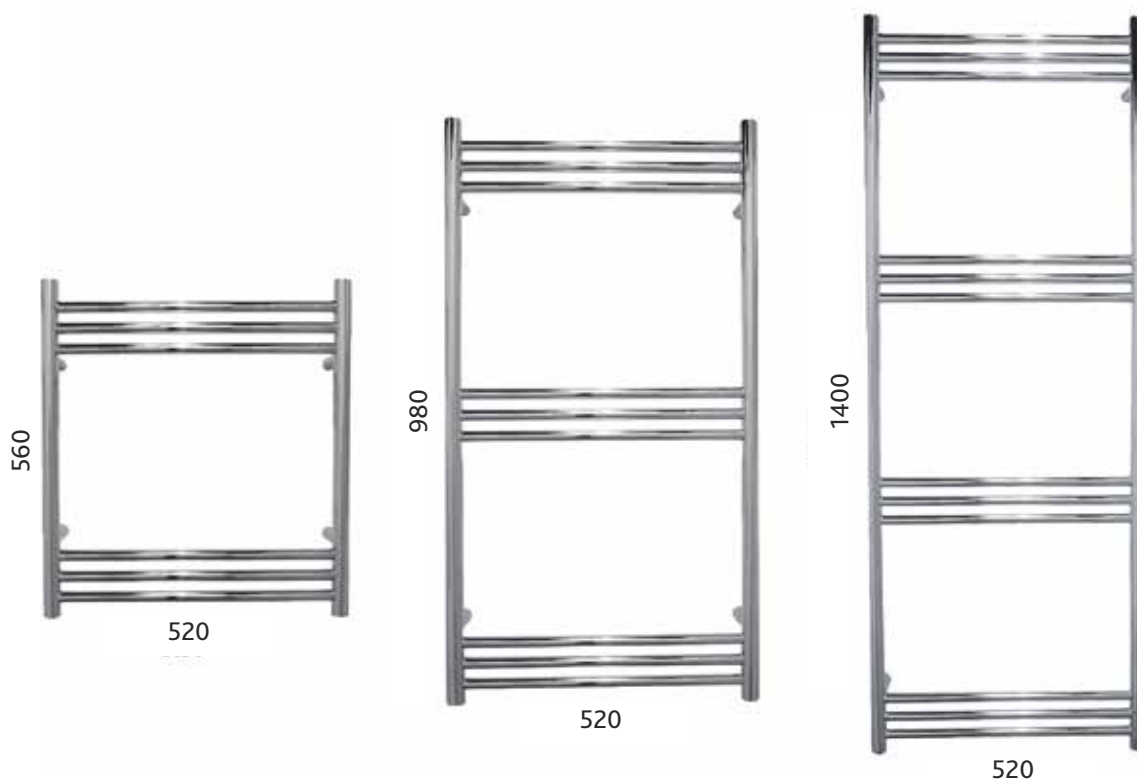

Model	Dimensions	BTU	Watts	RRP ex VAT
Lewes 560	560 x 520mm	938	275	£213.95
Lewes 980	980 x 520mm	1533	449	£301.50
Lewes 1400	1400 x 520mm	2109	618	£387.95

- The above prices are based on central heating format.
- Available in central heating, electric and dual fuel formats.
- For pipe centres, subtract 30mm from width. For dual fuel, pipe centres may differ.
- Satin finish is available, please add 30% to the price shown.
- Standard brackets are included with the towel rail unless otherwise stated.
- Standard (85mm) & short (60mm) brackets are available. Adjustable brackets are £29.95 extra when purchased with the rail. They are £79.90 when purchased separately. Please see page 92 for further details.
- The Sussex Range of towel rails are also available in electric only format. Electric formats start from an additional £89.95 with adjustable options also available. Please see page 90 for more details.
- Please see page 85, 86 and 87 for our valves.

25 YEAR GUARANTEE







Coombe

# BUXTED, COOMBE & ANSTY

Available in Central Heating, Electric & Dual Fuel

100% STAINLESS STEEL

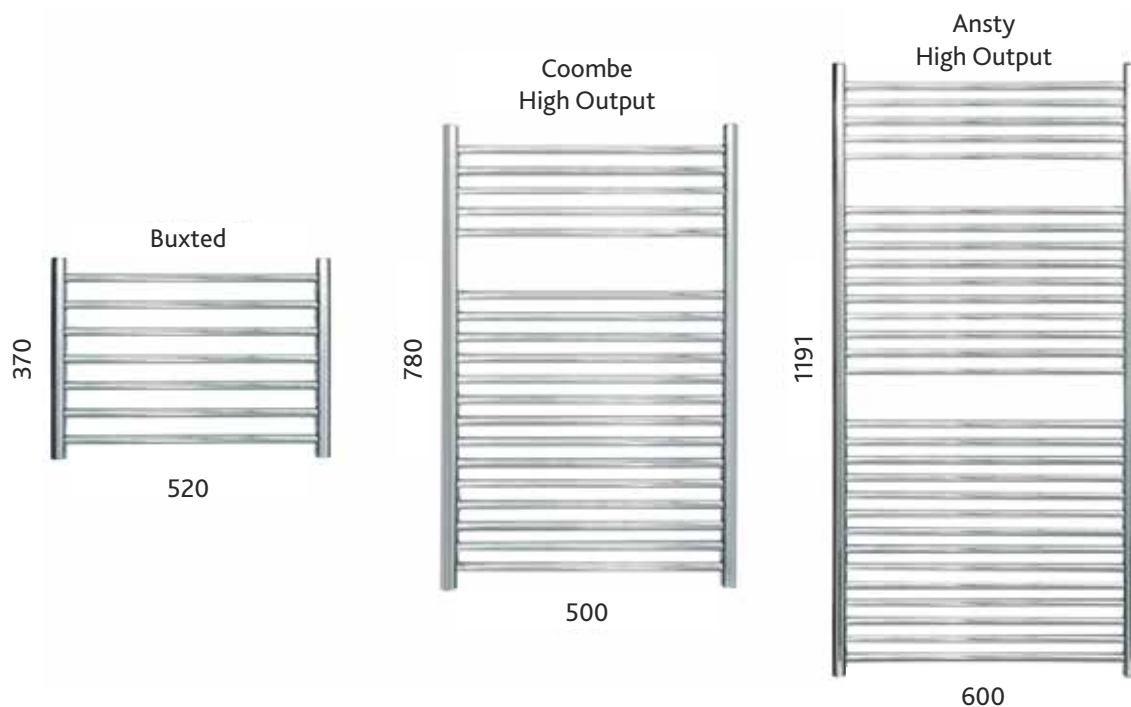

Model	Dimensions	BTU	Watts	RRP ex VAT
Buxted	370 x 520mm	840	246	£183.95
Coombe	780 x 500mm	1998	585	£399.95
Ansty	1191 x 600mm	2859	838	£626.50

- The above prices are based on central heating format.
- Available in central heating, electric and dual fuel formats.
- For pipe centres, subtract 30mm from width. For dual fuel, pipe centres may differ.
- Satin finish is available, please add 30% to the price shown.
- Standard brackets are included with the towel rail unless otherwise stated.
- Standard (85mm) & short (60mm) brackets are available. Adjustable brackets are £29.95 extra when purchased with the rail. They are £79.90 when purchased separately. Please see page 92 for further details.
- The Sussex Range of towel rails are also available in electric only format. Electric formats start from an additional £89.95 with adjustable options also available. Please see page 90 for more details.
- Please see page 85, 86 and 87 for our valves.

25 YEAR GUARANTEE



Adur 400

# ADUR Curved

Available in Central Heating, Electric & Dual Fuel

100% STAINLESS STEEL

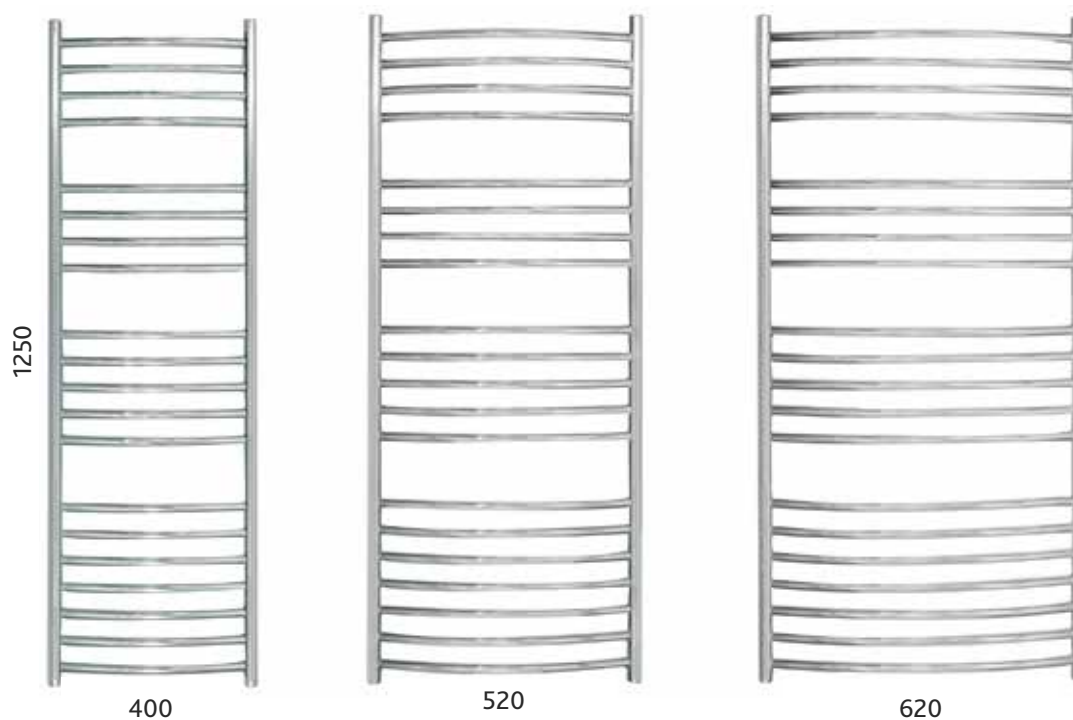

Model	Dimensions	BTU	Watts	RRP ex VAT
Adur 400	1250 x 400mm	2486	728	£346.50
Adur 520	1250 x 520mm	2597	761	£384.50
Adur 620	1250 x 620mm	2841	832	£422.95

- The above prices are based on central heating format.
- Available in central heating, electric and dual fuel formats.
- For pipe centres, subtract 30mm from width. For dual fuel, pipe centres may differ.
- Satin finish is available, please add 30% to the price shown.
- Standard brackets are included with the towel rail unless otherwise stated.
- Standard (85mm) & short (60mm) brackets are available. Adjustable brackets are £29.95 extra when purchased with the rail. They are £79.90 when purchased separately. Please see page 92 for further details.
- The Sussex Range of towel rails are also available in electric only format. Electric formats start from an additional £89.95 with adjustable options also available. Please see page 90 for more details.
- Please see page 85, 86 and 87 for our valves.

25 YEAR GUARANTEE

# CAMBER Curved

Available in Central Heating, Electric & Dual Fuel

100% STAINLESS STEEL

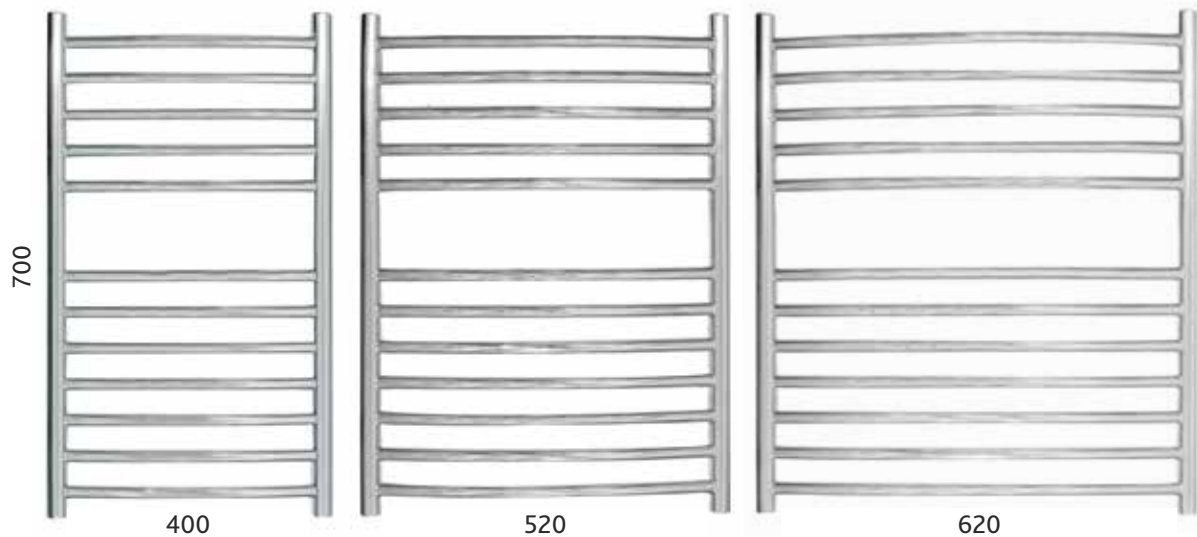

Model	Dimensions	BTU	Watts	RRP ex VAT
Camber 400	700 x 400mm	1449	425	£240.50
Camber 520	700 x 520mm	1572	460	£259.50
Camber 620	700 x 620mm	1763	517	£282.50

- The above prices are based on central heating format.
- Available in central heating, electric and dual fuel formats.
- For pipe centres, subtract 30mm from width. For dual fuel, pipe centres may differ.
- Satin finish is available, please add 30% to the price shown.
- Standard brackets are included with the towel rail unless otherwise stated.
- Standard (85mm) & short (60mm) brackets are available. Adjustable brackets are £29.95 extra when purchased with the rail. They are £79.90 when purchased separately. Please see page 92 for further details.
- The Sussex Range of towel rails are also available in electric only format. Electric formats start from an additional £89.95 with adjustable options also available. Please see page 90 for more details.
- Please see page 85, 86 and 87 for our valves.

25 YEAR GUARANTEE



Camber 520

# DESIGNER RAILS







# FINDON

Available in Central Heating, Electric & Dual Fuel

100% STAINLESS STEEL



Model	Dimensions	BTU	Watts	RRP ex VAT
Findon	1210 x 540mm	2654	778	£593.95

- Designed for extra practicability, this rail's curved bars protrude by a further 110mm from the front of the rail thereby increasing the number of towels that can be hung on it. This rail will particularly suit families.
- The above prices are based on central heating format.
- Available in central heating, electric and dual fuel formats.
- For pipe centres, subtract 30mm from width. For dual fuel, pipe centres may differ.
- Satin finish is available, please add 30% to the price shown.
- Short brackets are included with the towel rail unless otherwise stated.
- Standard (85mm) & short (60mm) brackets are available. Adjustable brackets are £29.95 extra when purchased with the rail. They are £79.90 when purchased separately. Please see page 92 for further details.
- The Sussex Range of towel rails are also available in electric only format. Electric formats start from an additional £89.95 with adjustable options also available. Please see page 90 for more details.
- Please see page 85, 86 and 87 for our valves.

25 YEAR GUARANTEE

# ALFRISTON

Available in Central Heating, Electric & Dual Fuel

100% STAINLESS STEEL

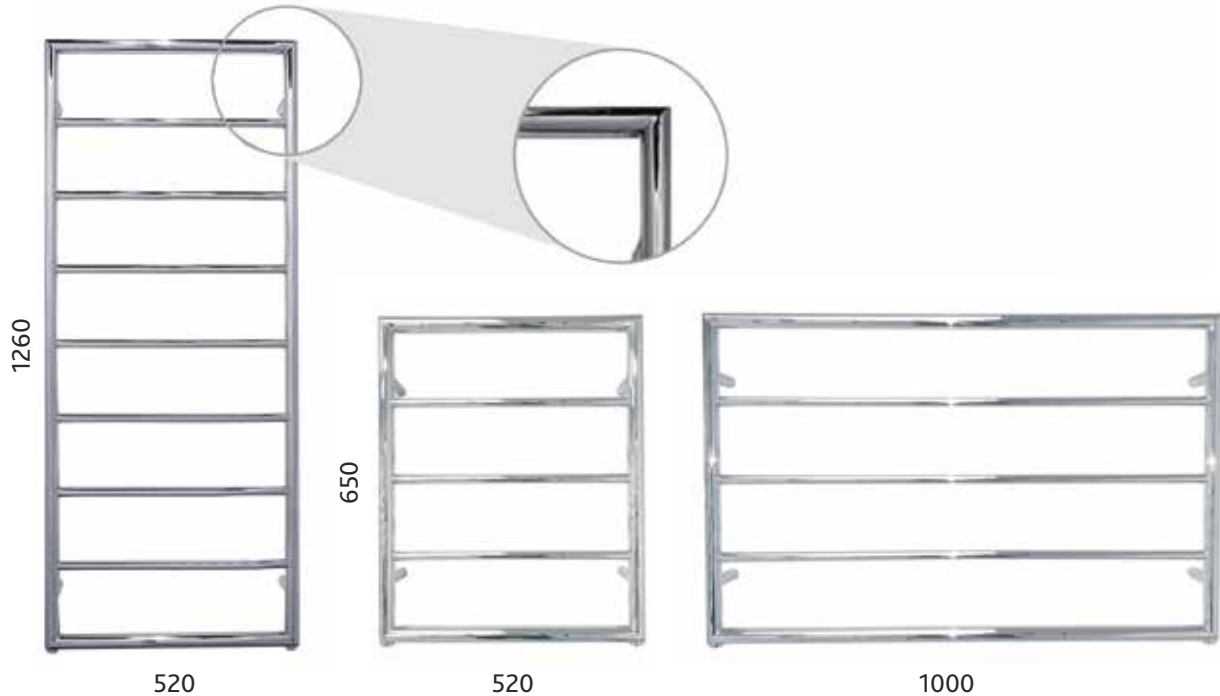

Model	Dimensions	BTU	Watts	RRP ex VAT
Alfriston 1260	1260 x 520mm	2051	601	£535.95
Alfriston 650	650 x 520mm	1060	311	£376.95
Alfriston 1000	650 x 1000mm	1389	407	£484.95

- The above prices are based on central heating format.
- Available in central heating, electric and dual fuel formats.
- For pipe centres, subtract 40mm from width. For dual fuel, pipe centres may differ.
- Satin finish is available, please add 30% to the price shown.
- Standard brackets are included with the towel rail unless otherwise stated.
- Standard (85mm) & short (60mm) brackets are available. Adjustable brackets are £29.95 extra when purchased with the rail. They are £79.90 when purchased separately. Please see page 92 for further details.
- The Sussex Range of towel rails are also available in electric only format. Electric formats start from an additional £89.95 with adjustable options also available. Please see page 90 for more details.
- Please see page 85, 86 and 87 for our valves.

25 YEAR GUARANTEE



Alfriston 1260/520



Fletching 1185

# FLETCHING

Available in Central Heating, Electric & Dual Fuel

100% STAINLESS STEEL

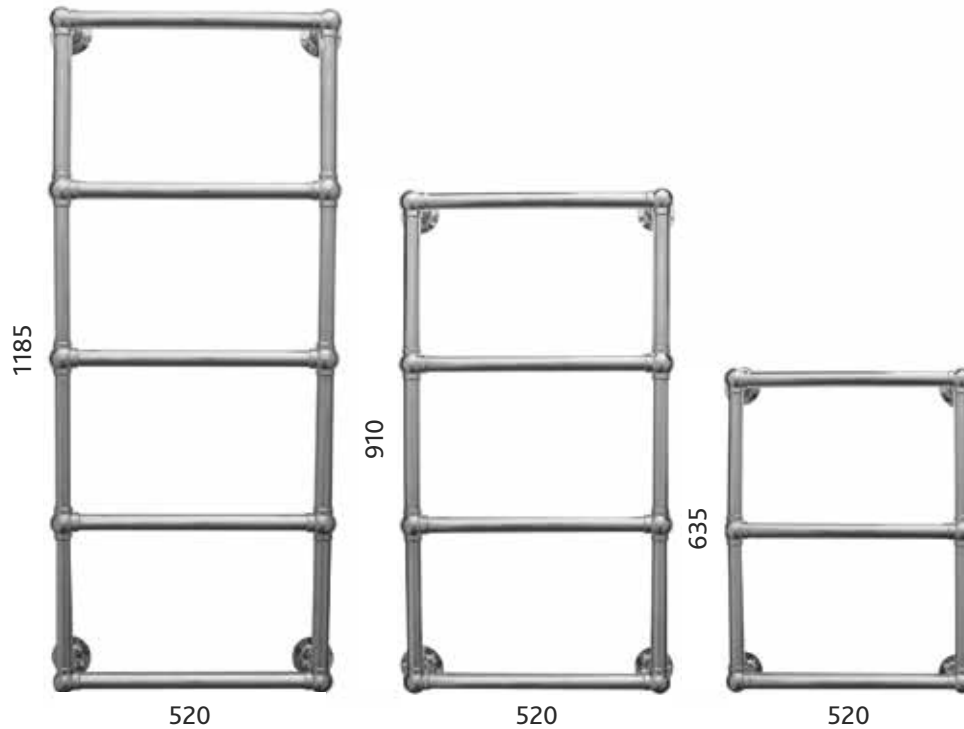

Model	Dimensions	BTU	Watts	RRP ex VAT
Fletching 1185	1185 x 520mm	1963	576	£724.95
Fletching 910	910 x 520mm	1431	420	£599.95
Fletching 635	635 x 520mm	1020	299	£524.95

- The above prices are based on central heating format.
- Available in central heating, electric and dual fuel formats. For the Fletching model there is a separate electric element inlet connection on the bottom right hand side (please note, the Fletching can be right hand only in electric format).
- This model has side tappings so the pipe centres will be dependent on the type of valves (when using Solar Angled Valves the pipe centres are 305mm). Please see our website for an image of the valve connection.
- Satin finish is available, please add 30% to the price shown.
- The Sussex Range of towel rails are also available in electric only format. Electric formats start from an additional £89.95 with adjustable options also available. Please see page 90 for more details. Please note, the electric element can be right hand only.
- Please see page 85, 86 and 87 for our valves.
- Being a traditional rail the Fletching brackets are not adjustable. In the insitu shot our customer has made up a plate bridging the gap difference between the tiles and the wall.

25 YEAR GUARANTEE

# FLETCHING FLOOR TO WALL

Available in Central Heating, Electric & Dual Fuel

100% STAINLESS STEEL



\*If you require an element please note it will need to be located in the floor.

Model	Dimensions	BTU	Watts	RRP ex VAT
Fletching Floor to Wall	1200 x 520mm	1858	544	£799.95

- Must be floor to wall mounted
- The above prices are based on central heating format.
- Available in central heating, electric and dual fuel formats. For the Fletching model in electric & dual fuel format there is a separate electric element inlet connection on the bottom right hand side. This rail is floor mounted therefore requiring the element to be located in the floor.
- This model has side tapings so the pipe centres will be dependent on the type of valves (when using Solar Angled Valves the pipe centres are 305mm). Please see our website for an image of the valve connection.
- Satin finish is available, please add 30% to the price shown.
- In electric and dual fuel format the rail can only be supplied with a **standard element which must be fitted on the right hand side**, see page 90 for this element.
- Please see page 85, 86 and 87 for our valves.
- Being a traditional rail the Fletching brackets are not adjustable.

25 YEAR GUARANTEE





# BRUNSWICK Square

Available in Central Heating, Electric & Dual Fuel

100% STAINLESS STEEL

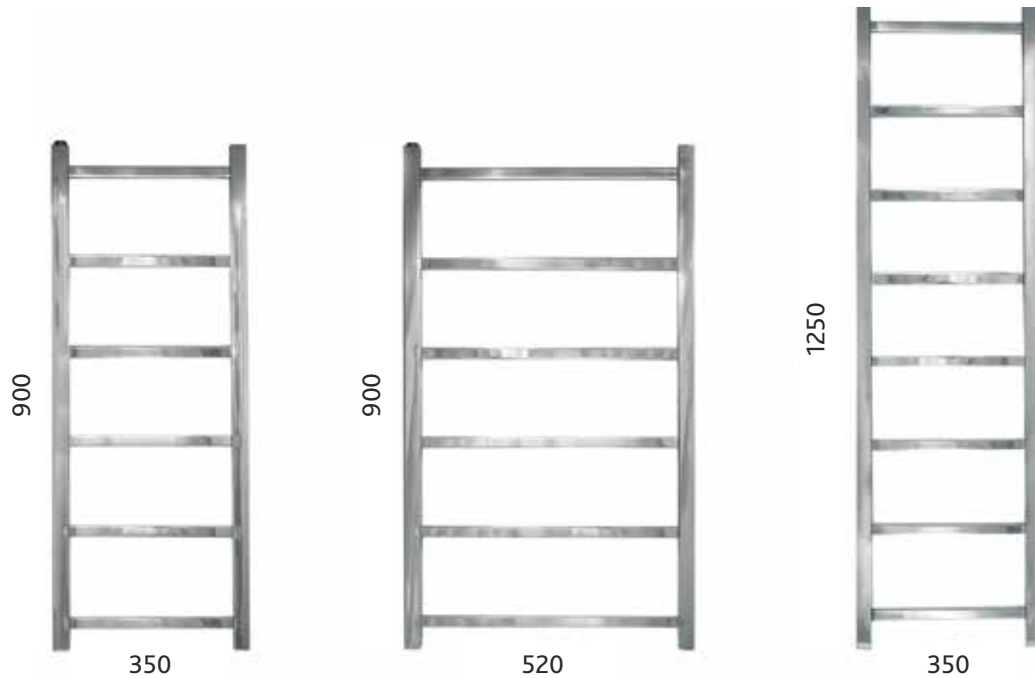

Model	Dimensions	BTU	Watts	RRP ex VAT
Brunswick 900/350	900 x 350mm	1111	326	£395.95
Brunswick 900/520	900 x 520mm	1290	378	£399.95
Brunswick 1250/350	1250 x 350mm	1398	410	£559.95

- The above prices are based on central heating format.
- Available in central heating, electric and dual fuel formats.
- Brunswick rails are supplied with adjustable brackets, overall projection from 70mm - 95mm.
- For pipe centres subtract 30mm from width. For dual fuel, pipe centres may vary.
- Satin finish is available, please call to check availability (same price as polished).
- The Sussex Range of towel rails are also available in electric only format. Electric formats start from an additional £89.95 with adjustable options also available. Please see page 90 for more details.
- Please see page 85, 86 and 87 for our valves.

25 YEAR GUARANTEE

# BRUNSWICK Square

Available in Central Heating, Electric & Dual Fuel

100% STAINLESS STEEL

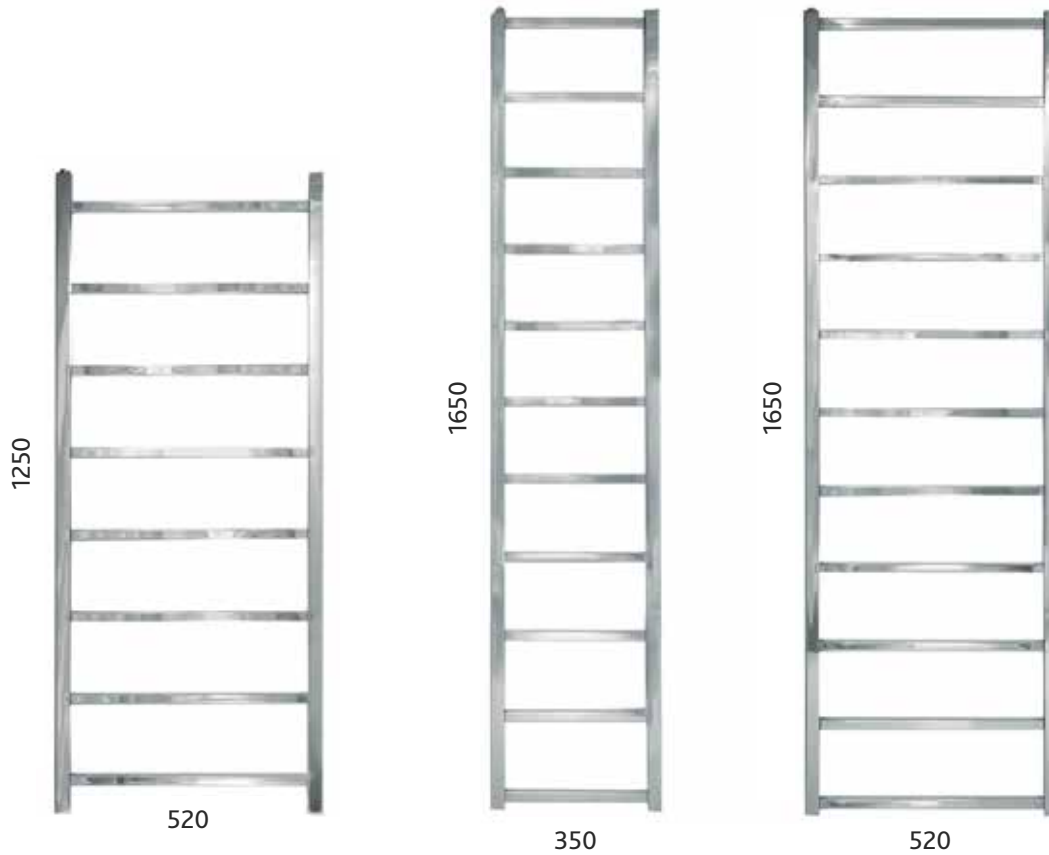

Model	Dimensions	BTU	Watts	RRP ex VAT
Brunswick 1250/520	1250 x 520mm	1638	480	£569.95
Brunswick 1650/350	1650 x 350mm	1838	539	£649.95
Brunswick 1650/520	1650 x 520mm	2162	633	£659.95

- The above prices are based on central heating format.
- Available in central heating, electric and dual fuel formats.
- Brunswick rails are supplied with adjustable brackets, overall projection from 70mm - 95mm.
- For pipe centres subtract 30mm from width. For dual fuel, pipe centres may vary.
- Satin finish is available, please call to check availability (same price as polished).
- The Sussex Range of towel rails are also available in electric only format. Electric formats start from an additional £89.95 with adjustable options also available. Please see page 90 for more details.
- Please see page 85, 86 and 87 for our valves.

25 YEAR GUARANTEE



Brunswick



# HICKSTEAD

Available in Central Heating, Electric & Dual Fuel

SIDE ARM WITH SQUARE PROFILE

100% STAINLESS STEEL

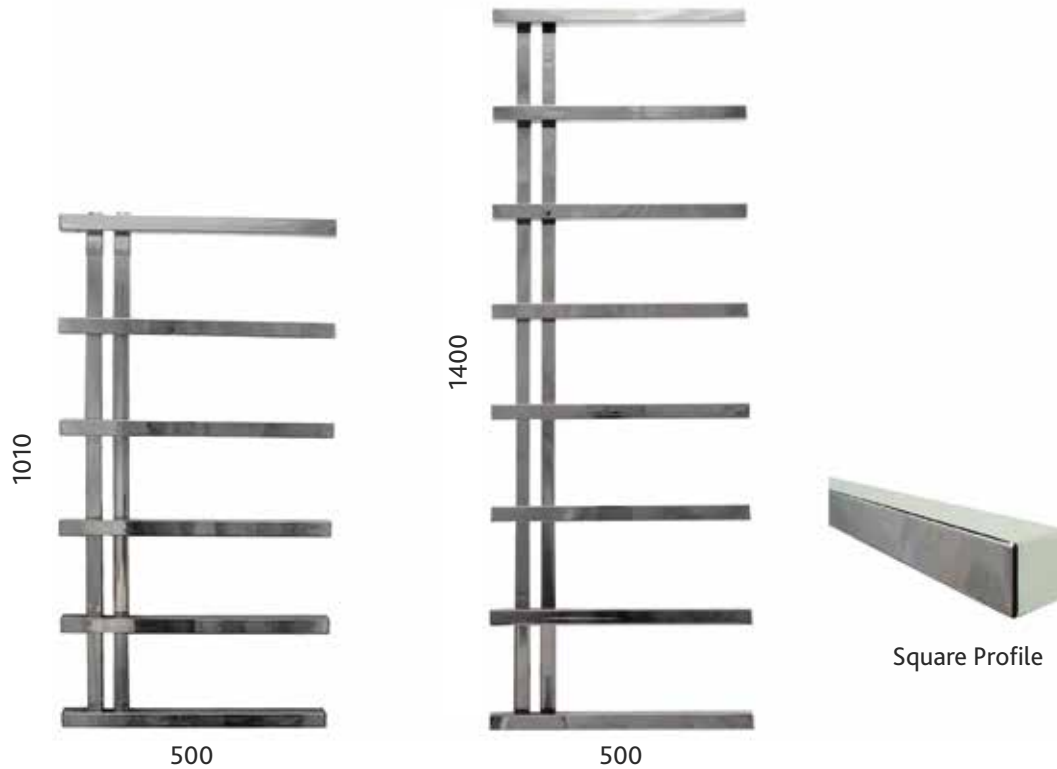

Model	Dimensions	BTU	Watts	RRP ex VAT
Hickstead 1010	1010 x 500mm	1291	378	£538.95
Hickstead 1400	1400 x 500mm	1722	505	£739.95

- The above prices are based on central heating format.
- Available in central heating, electric and dual fuel formats.
- Our Hickstead rails are supplied with square adjustable brackets which gives an overall projection of 100mm - 125mm.
- The pipe centres are 52mm. For dual fuel, pipe centres may differ.
- Satin finish is available, please call to check availability (same price as polished).
- The Hickstead can be installed either right armed or left armed. Please note when ordering electric only options, they will be supplied right armed as standard, should you require left armed please specify when ordering.
- The Sussex Range of towel rails are also available in electric only format. Electric formats start from an additional £89.95 with adjustable options also available. Please see page 90 for more details.
- Please see page 85, 86 and 87 for our valves.

25 YEAR GUARANTEE







# GOODWOOD

Available in Central Heating, Electric & Dual Fuel

SIDE ARM WITH OVAL PROFILE

100% STAINLESS STEEL

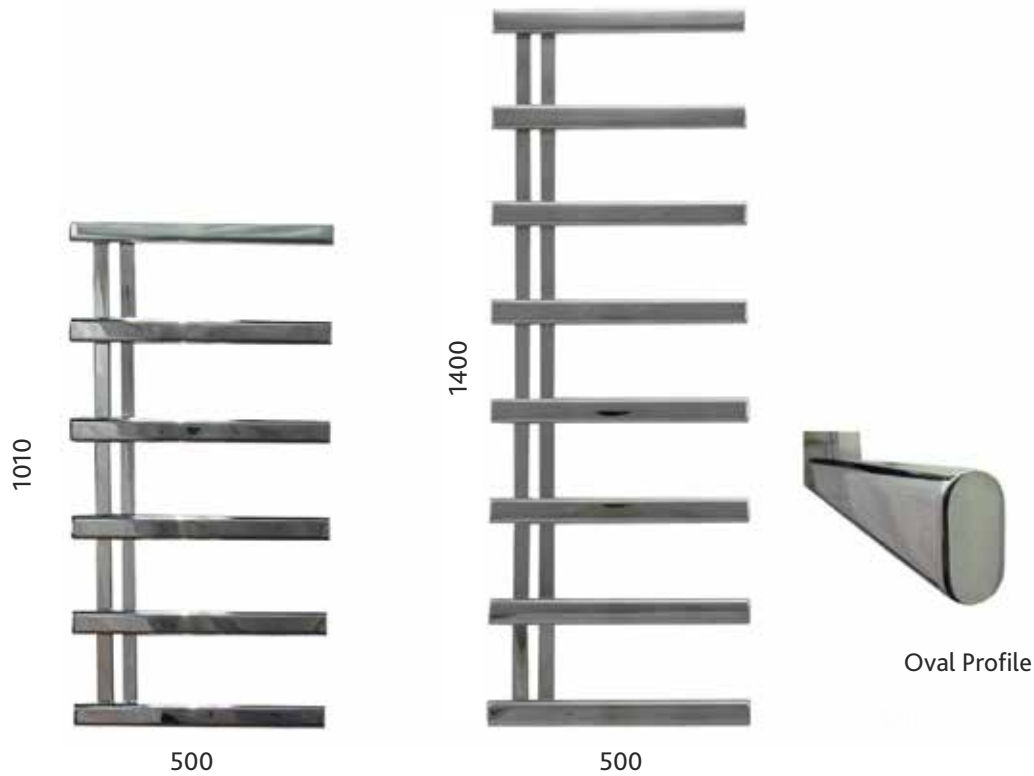

Model	Dimensions	BTU	Watts	RRP ex VAT
Goodwood 1010	1010 x 500mm	1489	436	£549.95
Goodwood 1400	1400 x 500mm	1986	582	£749.95

- The above prices are based on central heating format.
- Available in central heating, electric and dual fuel formats.
- Our Goodwood rails are supplied with square adjustable brackets which gives an overall projection of 95mm - 120mm.
- The pipe centres are 52mm. For dual fuel, pipe centres may differ.
- Satin finish is available, please call to check availability. Please add 30% to the price shown.
- The Goodwood can be installed either right armed or left armed. Please note when ordering electric only options, they will be supplied right armed as standard, should you require left armed please specify when ordering.
- The Sussex Range of towel rails are also available in electric only format. Electric formats start from an additional £89.95 with adjustable options also available. Please see page 90 for more details.
- Please see page 85, 86 and 87 for our valves.

25 YEAR GUARANTEE



£20 from the profits of each Rye towel rail is being donated to Lucky's Legacy Rescue. Lucky's are a wonderful 'on the ground' UK registered charity run entirely by volunteers from both Romania and the United Kingdom. Their goal is to work together to rescue, rehabilitate and rehome as many abandoned dogs and cats as possible. They work tirelessly to care for and nurture these forgotten animals before finally finding them wonderful forever homes. Their neutering campaigns are the final, vitally important step in relieving the often overwhelming suffering on the streets of Romania.

Rye



# RYE - LEANING LADDER RAIL

Available in Central Heating, Electric & Dual Fuel

100% STAINLESS STEEL

- Electric Only or Dual Fuel

When ordered in electric only or dual fuel format, two special element cover sleeves are supplied with the towel rail to enable you to still lean the rail on the floor. The cable exits are on the bottom or the back of the element sleeve. See below for prices.

- Dual Fuel

The Towel Rail has a side entry points for valves, so no need for a t-piece, just use a standard element & solar angled valves.

We recommend Solar Angled Valves for this rail. Please note valves need to be ordered separately, please see page 86 for details.

\*Please note when this rail is Electric Only or Dual Fuel the overall height of rail will increase to 1890mm.

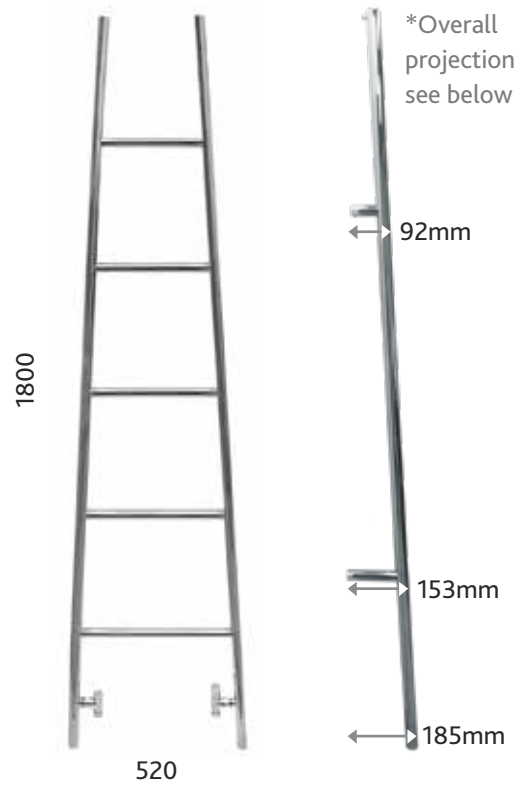

Model	Dimensions	BTU	Watts	RRP ex VAT
Rye	1800* x 520mm	1878	550	£485.50

- Leaning Ladder Rail

- The above prices are based on central heating format.

- Available in central heating, standard electric and standard dual fuel formats.

- This model has side tapplings so the pipe centres will be dependent on the type of valves (when using Solar Angled Valves the pipe centres are 340mm).

- Satin finish is available. Please call to check availability. Please add 30% to the price shown.

- This towel rail comes with its own unique bracket pack enabling it to lean on the wall. The top brackets are 60mm and the bottom brackets are 120.5mm.

- Please note the Rye comes with extension legs to accomodate the element in electric only or dual fuel format, it can only be used with the standard element.

- Dual Fuel Format - £84.95

- Electric Only Format - £109.95

25 YEAR GUARANTEE



# MIDHURST

Available in Central Heating, Electric & Dual Fuel

100% STAINLESS STEEL

Brackets attach to the wall, creating a partition within the room.



Model	Dimensions	BTU	Watts	RRP ex VAT
Midhurst	1765 x 560mm (including brackets)	3345	980	£749.95

- The above prices are based on central heating format.
- Available in central heating, standard electric and standard dual fuel formats.
- This model has side tapplings so the pipe centres will be dependant on the valves used, when using Solar Angled Vales the pipe centres are 345mm.
- This rail is floor mounted requiring the element to be located in the floor.
- Satin finish is available, please call to check availability. Please add 30% to the price shown.
- The Midhurst is supplied with adjustable brackets which give an overall projection of 560mm - 585mm.
- The Sussex Range of towel rails are also available in electric only format. Please see page 90 for more details. Due to the design of this rail, it can **only be used with the standard element**.
- Please see page 85, 86 and 87 for our valves.

25 YEAR GUARANTEE

# NEWHAVEN

Available in Central Heating, Electric & Dual Fuel

100% STAINLESS STEEL



Model	Dimensions	BTU	Watts	RRP ex VAT
Newhaven	480 x 520mm	1498	439	£313.50

- The above prices are based on central heating format.
- Available in central heating, electric and dual fuel formats.
- The Newhaven rail comes with short brackets as standard.
- Standard (85mm) & short (60mm) brackets are available. Adjustable brackets are £29.95 extra when purchased with the rail. They are £79.90 when purchased separately. Please see page 92 for further details.
- For pipe centres subtract 30mm from width. For dual fuel, pipe centres may differ.
- The overall projection for this rail is 360mm.
- Satin finish is available, please call to check availability, please add 30% to the price shown.
- The Sussex Range of towel rails are also available in electric only format. Electric formats start from an additional £89.95 with adjustable options also available. Please see page 90 for more details.
- Please see page 85, 86 and 87 for our valves.

25 YEAR GUARANTEE



# FEATURE RAILS





# MAYFIELD

Available in Central Heating, Electric & Dual Fuel

100% STAINLESS STEEL

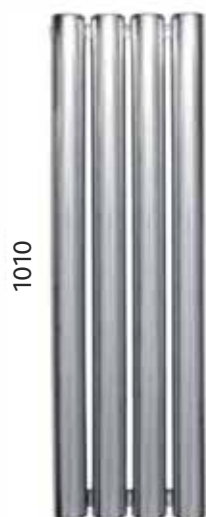

320



470



1010

Mayfield mounted horizontally  
\*Valves not included

Model	Dimensions	BTU	Watts	RRP ex VAT
Mayfield 320	1010 x 320mm	2689	788	£499.95
Mayfield 470	1010 x 470mm	3760	1102	£645.95

- Due to the Mayfield being extremely heavy there is a £50 delivery charge.
- The above prices are based on central heating format.
- Available in central heating, electric and dual fuel formats.
- When vertical, this model has side tapplings so pipe centres will be dependent on the type of valves. When horizontal, the pipe centres are 950mm. For dual fuel, the pipe centres may differ.
- Satin finish is available, please call to check availability (same price as polished).
- Overall projection is 140mm - 160mm.
- Please see page 85, 86 and 87 for our valves.
- Please note, the Mayfield comes with it's own element. This element is not adjustable but self regulates its heat output. Please see below for RRP prices ex VAT:
  - Element Only - additional £64.95
  - Dual Fuel Kit - additional £74.95
  - Electric Only - additional £94.95

25 YEAR GUARANTEE



# ARUN

Available in Central Heating, Electric & Dual Fuel

100% STAINLESS STEEL



Model	Dimensions	BTU	Watts	RRP ex VAT
Arun 1460/275	1460 x 275mm	2154	631	£765.55
Arun 1460/360	1460 x 360mm	2839	832	£875.55
Arun 1460/535	1460 x 535mm	3676	1077	£1,154.95

- **Due to the Arun being extremely heavy there is a £50 transport charge.**
- The above prices are based on central heating format.
- Available in central heating, electric and dual fuel formats.
- For pipe centres subtract 60mm from width (when mounted vertically). For dual fuel, pipe centres may differ.
- Can be mounted horizontally.
- Satin finish is available, please call to check availability (same price as polished).
- The Arun is also available in electric only format. Electric Formats start from an additional £89.95 with adjustable options also available. Please see page 90 for more details.
- Please see page 85, 86 and 87 for our valves.
- For our Arun range we offer optional towel hangers, these can be added to the front of the model making them perfect for kitchens and bathrooms. These are available in three different widths (275mm, 360mm and 535mm). Please see page 63 for further details.

25 YEAR GUARANTEE

# ARUN

Available in Central Heating, Electric & Dual Fuel

100% STAINLESS STEEL



Model	Dimensions	BTU	Watts	RRP ex VAT
Arun 1960/275	1960 x 275mm	2805	822	£1,040.55
Arun 1960/360	1960 x 360mm	3715	1088	£1,205.55
Arun 1960/535	1960 x 535mm	4210	1234	£1,315.55

- Due to the Arun being extremely heavy there is a £50 transport charge.
- The above prices are based on central heating format.
- Available in central heating, electric and dual fuel formats.
- For pipe centres subtract 60mm from width (when mounted vertically). For dual fuel, pipe centres may differ.
- Satin finish is available, please call to check availability (same price as polished).
- The Arun is also available in electric only format. Electric Formats start from an additional £89.95 with adjustable options also available. Please see page 90 for more details.
- Please see page 85, 86 and 87 for our valves.
- For our Arun range we offer optional towel hangers, these can be added to the front of the model making them perfect for kitchens and bathrooms. These are available in three different widths (275mm, 360mm and 535mm). Please see page 63 for further details.

25 YEAR GUARANTEE



# ARUN OPTIONAL TOWEL HANGERS & ARUN MOUNTED HORIZONTALLY

Available in Central Heating, Electric & Dual Fuel  
100% STAINLESS STEEL



- Arun Towel Hanger - £109.95 ex VAT
- We supply optional towel hangers which when fitted to these models will allow you to air and dry your towels. The Arun towel hangers, like the Arun model are available in both polished and satin finish.
- Our Arun model can be mounted vertically and horizontally, increasing their functionality as well as versatility.
- Mount it vertically to make a strong statement or horizontally to create a classic look. However you choose to use your Arun model it will be a stylish, as well as functional feature in your home.
- When mounted horizontally the Arun is available in central heating, dual fuel and electric format.
- When mounted horizontally, electric formats start from an additional £89.95 with adjustable options also available. Please see page 90 for more details.
- Due to the Arun being extremely heavy there is a £50 transport charge.

# HOVE

Available in Central Heating, Electric & Dual Fuel

100% STAINLESS STEEL

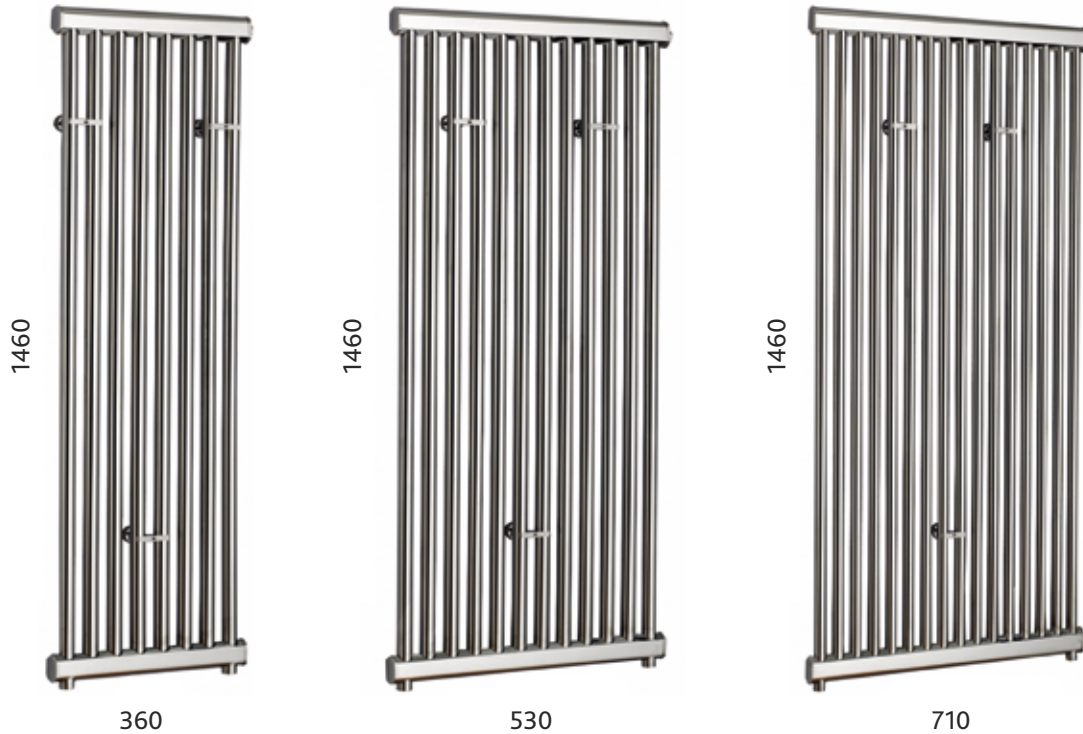

Model	Dimensions	BTU	Watts	RRP ex VAT
Hove 1460/360	1460 x 360mm	2406	705	£655.55
Hove 1460/530	1460 x 530mm	2785	816	£985.55
Hove 1460/710	1460 x 710mm	3498	1025	£1,204.50

- Due to the Hove being extremely heavy there is a £50 transport charge.
- The above prices are based on central heating format.
- Available in central heating, electric and dual fuel formats.
- For pipe centres subtract 60mm from width (when mounted vertically). For dual fuel, pipe centres may differ.
- Can be mounted horizontally.
- Satin finish is available, please call to check availability. Please add 30% to the price shown.
- The Hove is available in electric only format. Electric Formats start from an additional £89.95 with adjustable options also available. Please see page 90 for more details.
- Please see page 85, 86 and 87 for our valves.
- For our Hove range we offer optional towel hangers, these can be added to the front of the model making them perfect for kitchens and bathrooms. These are available in three different widths (360mm, 530mm & 710). Please see page 66 for further details.

25 YEAR GUARANTEE



# HOVE

Available in Central Heating, Electric & Dual Fuel

100% STAINLESS STEEL

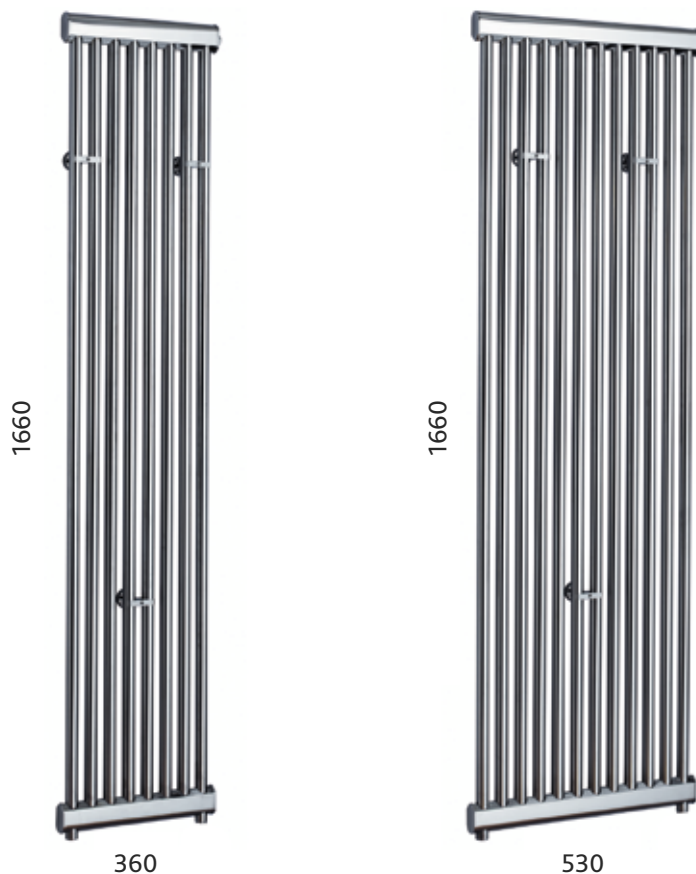

Model	Dimensions	BTU	Watts	RRP ex VAT
Hove 1660/360	1660 x 360mm	2944	863	£857.95
Hove 1660/530	1660 x 530mm	3408	999	£1,095.55

- **Due to the Hove being extremely heavy there is a £50 transport charge.**
- The above prices are based on central heating format.
- Available in central heating, electric and dual fuel formats.
- For pipe centres subtract 60mm from width (when mounted vertically). For dual fuel, pipe centres may differ.
- Satin finish is available, please call to check availability. Please add 30% to the price shown.
- The Hove is available in electric only format. Electric Formats start from an additional £89.95 with adjustable options also available. Please see page 90 for more details.
- Please see page 85, 86 and 87 for our valves.
- For our Hove range we offer optional towel hangers, these can be added to the front of the model making them perfect for kitchens and bathrooms. These are available in three different widths (360mm, 530mm & 710). Please see page 66 for further details.

25 YEAR GUARANTEE

# HOVE OPTIONAL TOWEL HANGERS & HOVE MOUNTED HORIZONTALLY

Available in Central Heating, Electric & Dual Fuel  
100% STAINLESS STEEL



- Hove Towel Hanger - **£76.95 ex VAT**
- We supply optional towel hangers which when fitted to these models will allow you to air and dry your towels. The Hove towel hangers, like the Hove model are available in both polished and satin finish.
- Our Hove model can be mounted vertically and horizontally, increasing their functionality as well as versatility.
- Mount it vertically to make a strong statement or horizontally to create a classic look. However you choose to use your Hove model it will be a stylish, as well as functional feature in your home.
- When mounted horizontally the Hove is available in central heating, dual fuel and electric format.
- When mounted horizontally, electric formats start from an additional £89.95 with adjustable options also available. Please see page 90 for more details.
- **Due to the Hove being extremely heavy there is a £50 transport charge.**



# BLACK EDITION

In 2019 we introduced the "**Black Edition**" range of Stainless Steel Heated Towel Rails to the Sussex Range.

What stands the Black Edition Towel Rail apart from the competition is that it is, as always, manufactured from **100% stainless steel**. The stainless steel towel rail is then powder coated black.

As the rail is manufactured from stainless steel rather than the standard, mild steel, the rail will not rust, flake or corrode.

Stainless steel is as always the durable, sustainable choice, manufactured from over 90% recycled material and 100% recyclable in itself.

In order to maintain the ethical sustainability of all of our products across the range, we have chosen to powder coat the stainless steel.

Powder coating is highly protective of the environment, it contains no solvents and emits negligible, if any, polluting VOCs into the atmosphere.

Powder coating is a clean process, allowing exhaust air from the coating booth to be returned to the plant.

Powder overspray can be retrieved and reused and there is no costly waste disposal equipment as unused powder can be reclaimed and returned to a hopper.

As always the rails are available from stock and carry a 25 year guarantee on the body and 5 years on the finish.

We trust you will enjoy this addition to the collection.

# BLACK EDITION OUSE

Available in Central Heating, Electric & Dual Fuel

100% STAINLESS STEEL POWDER COATED



Model	Dimensions	BTU	Watts	RRP ex VAT
Black Edition Ouse	700 x 400mm	1380	404	£212.95
Black Edition Ouse	700 x 520mm	1500	440	£221.90

- The above prices are based on central heating format.
- Available in central heating, electric and dual fuel formats.
- For pipe centres, subtract 30mm from width. For dual fuel, pipe centres may differ.
- Manufactured from 100% stainless steel powder coated black.
- Standard brackets are included with the towel rail unless otherwise stated.
- Standard (85mm) & short (60mm) brackets are available. Please see page 92 for further details.
- Electric version of the rail available for an additional £89.95, please see page 90 for details.
- We recommend the complementary black cable cover when purchasing an electric only version of the rail. The cable cover retails at £38.90 ex VAT. See page 84.
- Black profile valves available alternatively Satin accessories complement the finish well. See pages 84 - 90.

25 YEAR GUARANTEE ON BODY 5 YEAR GUARANTEE ON FINISH



# BLACK EDITION ASHDOWN

Available in Central Heating, Electric & Dual Fuel

100% STAINLESS STEEL POWDER COATED

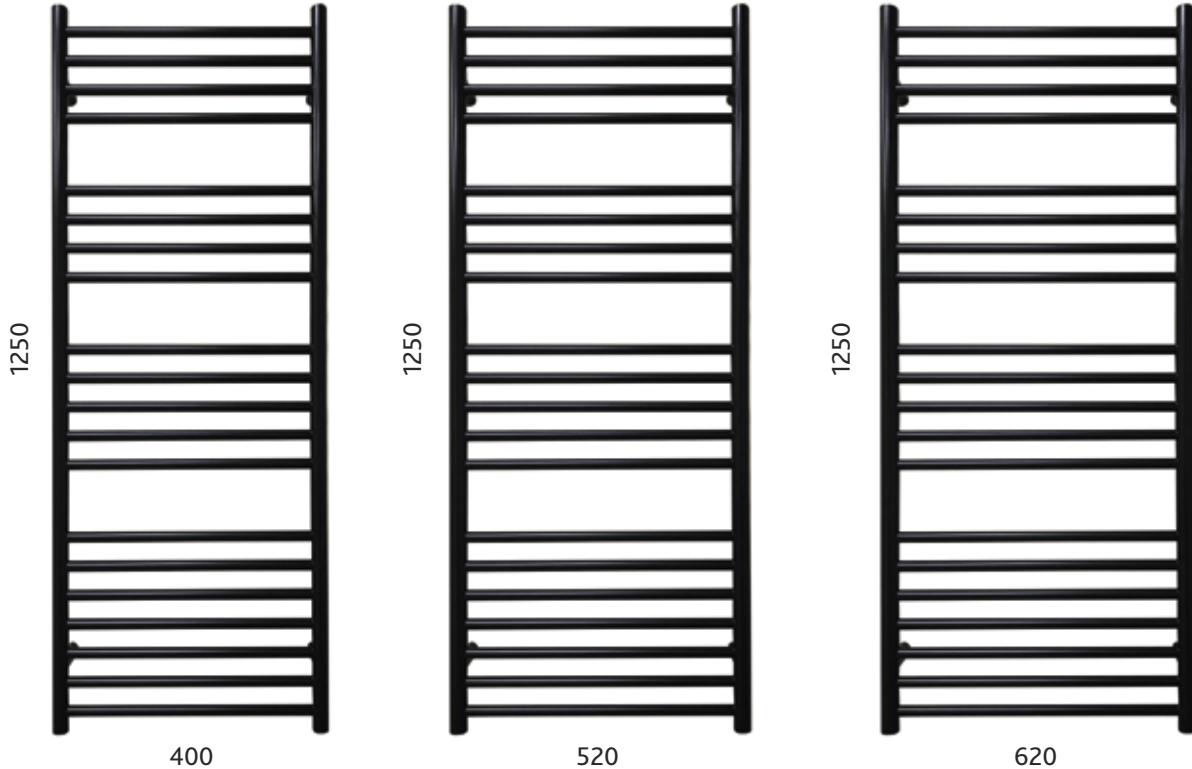

Model	Dimensions	BTU	Watts	RRP ex VAT
Black Edition Ashdown 400	1250mm x 400mm	2368	694	£301.90
Black Edition Ashdown 520	1250mm x 520mm	2500	733	£322.90
Black Edition Ashdown 620	1250mm x 620mm	2726	799	£375.80

- The above prices are based on central heating format.
- Available in central heating, electric and dual fuel formats.
- For pipe centres, subtract 30mm from width. For dual fuel, pipe centres may differ.
- Manufactured from 100% stainless steel powder coated black.
- Standard brackets are included with the towel rail unless otherwise stated.
- Standard (85mm) & short (60mm) brackets are available. Please see page 92 for further details.
- Electric version of the rail available for an additional £89.95, please see page 90 for details.
- We recommend the complementary black cable cover when purchasing an electric only version of the rail. The cable cover retails at £38.90 ex VAT. See page 84.
- Black profile valves available alternatively Satin accessories complement the finish well. See pages 84 - 90.

25 YEAR GUARANTEE ON BODY 5 YEAR GUARANTEE ON FINISH





# BLACK EDITION BEACON

Available in Central Heating, Electric & Dual Fuel

100% STAINLESS STEEL POWDER COATED

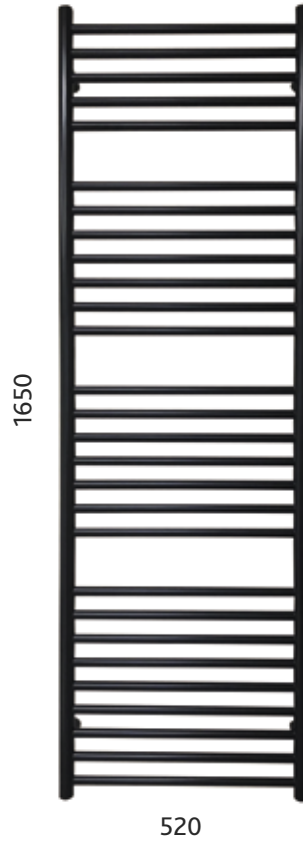

Model	Dimensions	BTU	Watts	RRP ex VAT
Black Edition Beacon	1650mm x 520mm	2932	859	£582.50

- The above prices are based on central heating format.
- Available in central heating, electric and dual fuel formats.
- For pipe centres, subtract 30mm from width. For dual fuel, pipe centres may differ.
- Manufactured from 100% stainless steel powder coated black.
- Standard brackets are included with the towel rail unless otherwise stated.
- Standard (85mm) & short (60mm) brackets are available. Please see page 92 for further details.
- Electric version of the rail available for an additional £89.95, please see page 90 for details.
- We recommend the complementary black cable cover when purchasing an electric only version of the rail. The cable cover retails at £38.90 ex VAT. See page 84.
- Black profile valves available alternatively Satin accessories complement the finish well. See pages 84 - 90.

25 YEAR GUARANTEE ON BODY 5 YEAR GUARANTEE ON FINISH



# BLACK EDITION NEWICK

Available in Central Heating, Electric & Dual Fuel

100% STAINLESS STEEL POWDER COATED

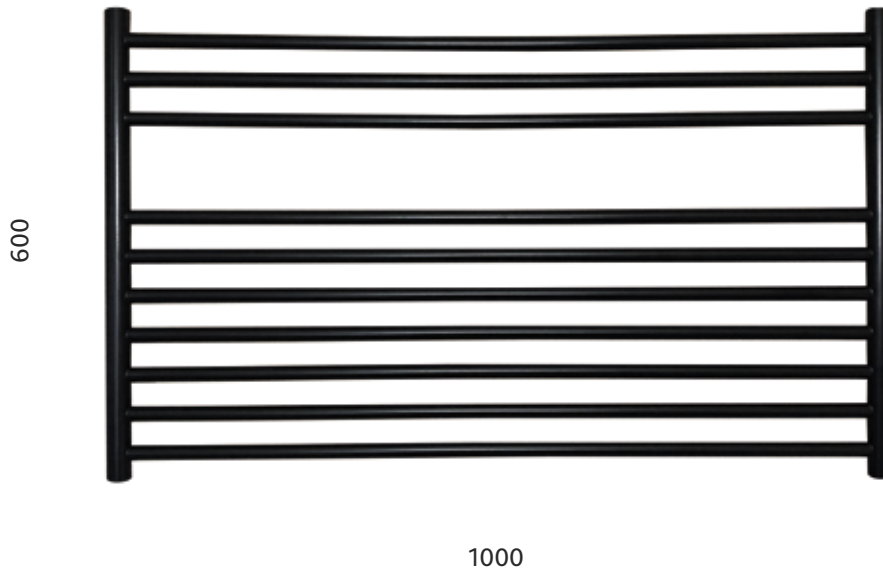

Model	Dimensions	BTU	Watts	RRP ex VAT
Black Edition Newick	600 x 1000mm	1885	552	£299.80

- The above prices are based on central heating format.
- Available in central heating, electric and dual fuel formats.
- For pipe centres, subtract 30mm from width. For dual fuel, pipe centres may differ.
- Manufactured from 100% stainless steel powder coated black.
- Standard brackets are included with the towel rail unless otherwise stated.
- Standard (85mm) & short (60mm) brackets are available. Please see page 92 for further details.
- Electric version of the rail available for an additional £89.95, please see page 90 for details.
- We recommend the complementary black cable cover when purchasing an electric only version of the rail. The cable cover retails at £38.90 ex VAT. See page 84.
- Black profile valves available alternatively Satin accessories complement the finish well. See pages 84 - 90.

25 YEAR GUARANTEE ON BODY 5 YEAR GUARANTEE ON FINISH





Black Edition Rusper

# BLACK EDITION RUSPER & PEVENSEY

Available in Central Heating, Electric & Dual Fuel

100% STAINLESS STEEL POWDER COATED

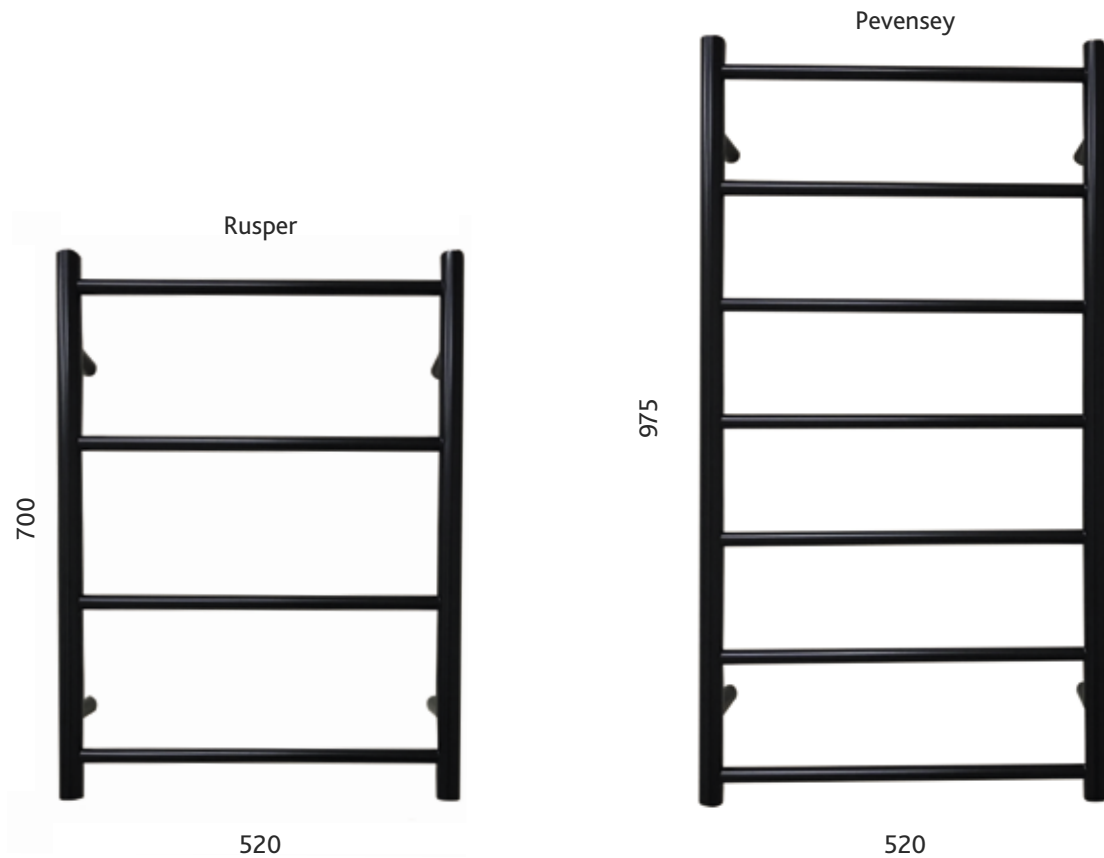

Model	Dimensions	BTU	Watts	RRP ex VAT
Black Edition Rusper	700mm x 520mm	740	217	£193.50
Black Edition Pevensey	975mm x 520mm	1381	405	£266.90

- The above prices are based on central heating format.
- Available in central heating, electric and dual fuel formats.
- For pipe centres, subtract 30mm from width. For dual fuel, pipe centres may differ.
- Manufactured from 100% stainless steel powder coated black.
- Standard brackets are included with the towel rail unless otherwise stated.
- Standard (85mm) & short (60mm) brackets are available. Please see page 92 for further details.
- Electric version of the rail available for an additional £89.95, please see page 90 for details.
- We recommend the complementary black cable cover when purchasing an electric only version of the rail. The cable cover retails at £38.90 ex VAT. See page 84.
- Black profile valves available alternatively Satin accessories complement the finish well. See pages 84 - 90.

25 YEAR GUARANTEE ON BODY 5 YEAR GUARANTEE ON FINISH





# BLACK EDITION LINDFIELD & ARDINGLY

Available in Central Heating, Electric & Dual Fuel

100% STAINLESS STEEL POWDER COATED

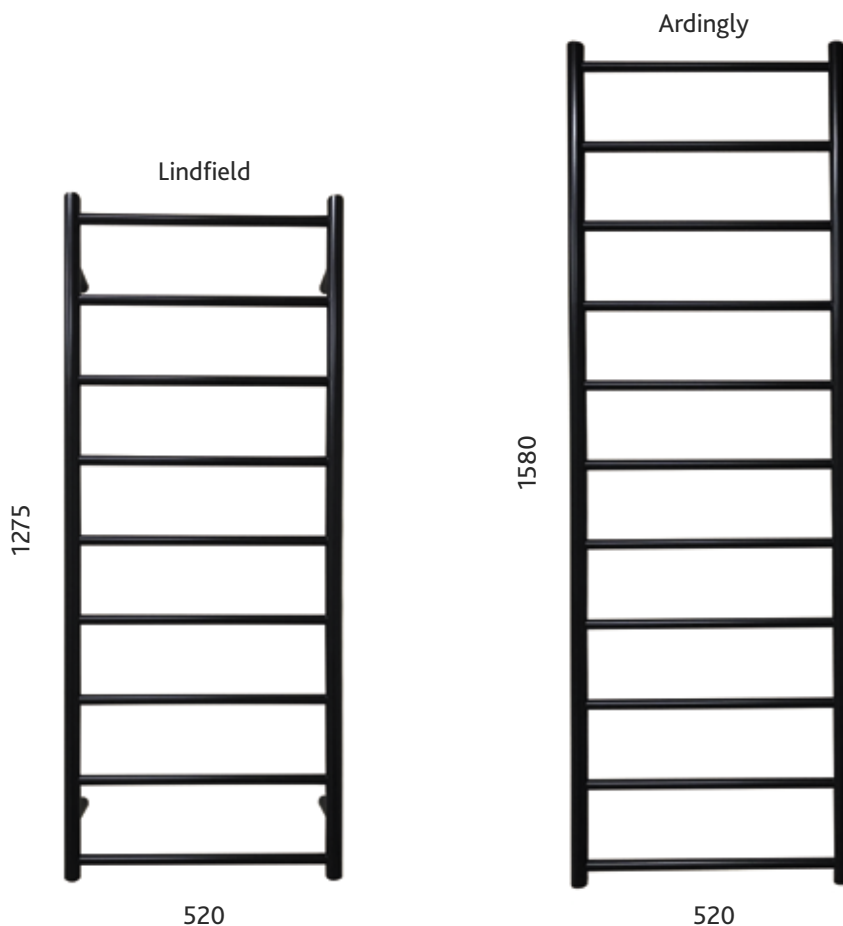

Model	Dimensions	BTU	Watts	RRP ex VAT
Black Edition Lindfield	1275mm x 520mm	1726	506	£316.50
Black Edition Ardingly	1580mm x 520mm	2114	617	£387.50

- The above prices are based on central heating format.
- Available in central heating, electric and dual fuel formats.
- For pipe centres, subtract 30mm from width. For dual fuel, pipe centres may differ.
- Manufactured from 100% stainless steel powder coated black.
- Standard brackets are included with the towel rail unless otherwise stated.
- Standard (85mm) & short (60mm) brackets are available. Please see page 92 for further details.
- Electric version of the rail available for an additional £89.95, please see page 90 for details.
- We recommend the complementary black cable cover when purchasing an electric only version of the rail. The cable cover retails at £38.90 ex VAT. See page 84.
- Black profile valves available alternatively Satin accessories complement the finish well. See pages 84 - 90.

25 YEAR GUARANTEE ON BODY 5 YEAR GUARANTEE ON FINISH



Black Edition Alfriston

# BLACK EDITION ALFRISTON

Available in Central Heating, Electric & Dual Fuel

100% STAINLESS STEEL POWDER COATED

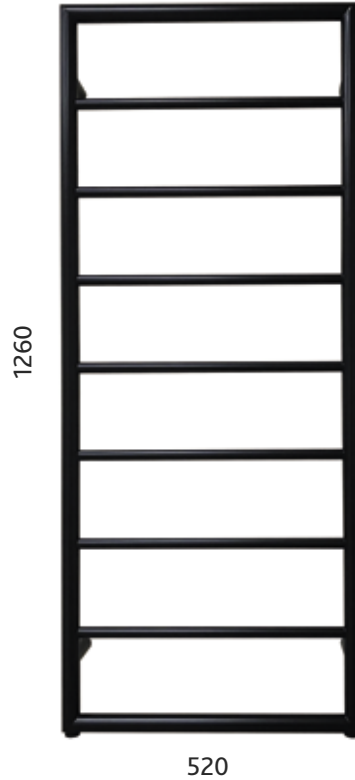

Model	Dimensions	BTU	Watts	RRP ex VAT
Black Edition Alfriston	1260mm x 520mm	2051	601	£534.50

- The above prices are based on central heating format.
- Available in central heating, electric and dual fuel formats.
- For pipe centres, subtract 40mm from width. For dual fuel, pipe centres may differ.
- Manufactured from 100% stainless steel powder coated black.
- Standard brackets are included with the towel rail unless otherwise stated.
- Standard (85mm) & short (60mm) brackets are available. Please see page 92 for further details.
- Electric version of the rail available for an additional £89.95, please see page 90 for details.
- We recommend the complementary black cable cover when purchasing an electric only version of the rail. The cable cover retails at £38.90 ex VAT. See page 84.
- Black profile valves available alternatively Satin accessories complement the finish well. See pages 84 - 90.

25 YEAR GUARANTEE ON BODY 5 YEAR GUARANTEE ON FINISH

# BLACK EDITION RYE

Available in Central Heating, Electric & Dual Fuel

100% STAINLESS STEEL POWDER COATED

- Electric Only or Dual Fuel

When ordered in electric only or dual fuel format, two special element cover sleeves are supplied with the towel rail to enable you to still lean the rail on the floor. The cable exits are on the bottom or the back of the element sleeve. Please see our website for an image of the extension legs, and below for prices.

- Dual Fuel

The Towel Rail has a side entry points for valves, so no need for a t-piece, just use a standard element & solar angled valves.

We recommend Solar Angled Valves for this rail. Please note valves need to be ordered separately, please see page 86 for details.

\*Please note when this rail is Electric Only or Dual Fuel the overall height of rail will increase to 1890mm.

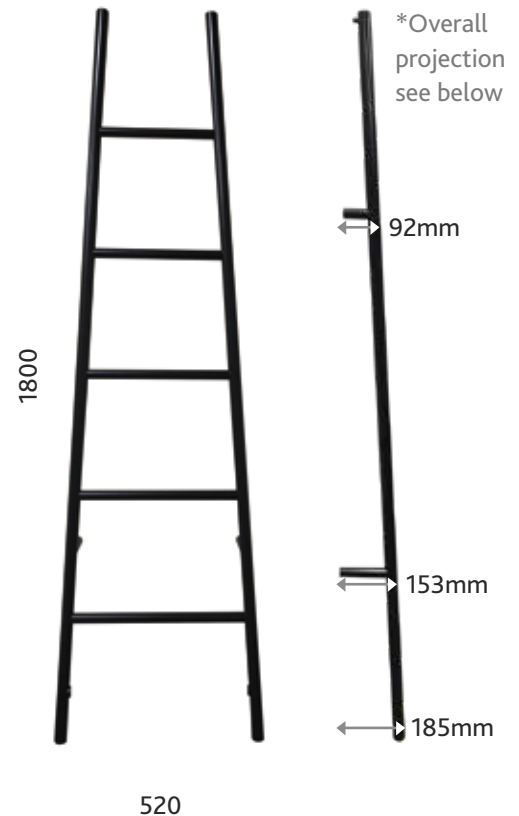

Model	Dimensions	BTU	Watts	RRP ex VAT
Black Edition Rye	1800mm* x 520mm	1878	550	£484.50

- Leaning Ladder Rail
- The above prices are based on central heating format.
- Available in central heating, electric and dual fuel formats.
- This model has side tapplings so the pipe centres will be dependent on the type of valves (when using Solar Angled Valves the pipe centres are 340mm).
- Manufactured from 100% stainless steel powder coated black.
- This towel rail comes with its own unique bracket pack enabling it to lean on the wall. The top brackets are 60mm and the bottom brackets are 120.5mm.
- Black profile valves available alternatively Satin accessories complement the finish well. See pages 84 - 90.
- Please note the Rye comes with extension legs to accomodate the element in electric only or dual fuel format, it can only be used with the standard element.
  - Dual Fuel Format - £84.95
  - Electric Only Format - £99.95

25 YEAR GUARANTEE ON BODY 5 YEAR GUARANTEE ON FINISH



**LUCKY'S LEGACY**  
RESCUE

£20 from the profits of each Rye towel rail is being donated to Lucky's Legacy Rescue. Lucky's are a wonderful 'on the ground' UK registered charity run entirely by volunteers from both Romania and the United Kingdom. Their goal is to work together to rescue, rehabilitate and rehome as many abandoned dogs and cats as possible. They work tirelessly to care for and nurture these forgotten animals before finally finding them wonderful forever homes. Their neutering campaigns are the final, vitally important step in relieving the often overwhelming suffering on the streets of Romania.

Black Edition Rye

# BLACK ACCESSORIES

## BLACK PROFILE VALVES - £82.95

PRODUCT CODE: VWP-B

- Sits neatly within the towel rail dimensions.
- Not suitable for use in a Dual Fuel installation.



## BLACK STANDARD ELEMENT CABLE COVER - £38.90

PRODUCT CODE: AECC-B

- Perfect for when you do not want a visible element cable.
- For use with standard element only.
- Please note; If using short brackets the pipe will need to be shortened or sunk into the wall.



## BLACK PIPE COVER KIT - £28.95

PRODUCT CODE: PCOV

- 17mm Black powder coated pipe cover kit with round shrouds which fits over the copper pipe making it ideal for applications where you do not want copper pipe exposed.



# VALVES - Pipes from Floor

ALL VALVES COME AS A PAIR

## SOLAR STRAIGHT VALVES - £79.95

PRODUCT CODE: VFS

- Manufactured from Chrome Plated brass in Italy to exacting standards.
- Available with a polished or satin finish.

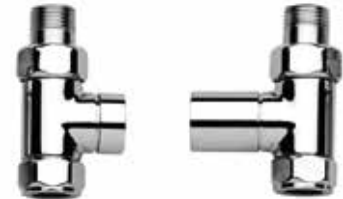

## STRAIGHT TRVS - £94.95

PRODUCT CODE: VFSTRV

- Thermostatic valve.
- Manufactured from Chrome Plated brass in Italy to exacting standards..
- Available with a polished or satin finish.



## SQUARE STRAIGHT VALVES - £89.95

PRODUCT CODE: VFSQ

- Manufactured from Chrome Plated brass in Italy to exacting standards.
- Available with a polished or satin finish.



## BRUNSWICK STRAIGHT VALVES - £189.95

PRODUCT CODE: VFB

- Manufactured from Chrome Plated brass in Italy to exacting standards with square shroud covering connections to rail and pipe.
- Available with a polished or satin finish.



- Prices shown are ex VAT.
- Satin finish is available. Please add 30% to the price shown.
- When ordering satin valves, please add S to the product code.
- Mixed valves are available for use with Dual Fuel Kits. Please see page 89.

5 YEAR GUARANTEE

# VALVES - Pipes from Wall

ALL VALVES COME AS A PAIR

## PROFILE VALVES - £89.95

PRODUCT CODE: VWP

- Manufactured from Chrome Plated brass in Italy to exacting standards.
- Sits neatly within the towel rail dimensions.
- Available with a polished, satin or black finish.
- Not suitable for dual fuel.
- **Black finish also available at £82.95, see page 84.**



## STREAMLINE TRVs - £149.95

PRODUCT CODE: VWSTRTRV

- Thermostatic valve.
- Manufactured from Chrome Plated brass in Italy to exacting standards.
- Sits neatly within the towel rail dimensions.
- Available with a polished or satin finish.
- Not suitable for dual fuel. Angled only.



## SQUARE PROFILE VALVES - £119.95

PRODUCT CODE: VSQP

- Manufactured from Chrome Plated brass in Italy to exacting standards.
- Sits neatly within the towel rail dimensions.
- Available with a polished or satin finish.
- Not suitable for dual fuel. Angled only.



## SQUARE STREAMLINE TRVs - £269.95

PRODUCT CODE: VWSQLTRV

- Thermostatic valve.
- Manufactured from Chrome Plated brass in Italy to exacting standards.
- Sits neatly within the towel rail dimensions.
- Comes with square shroud covering connections to rail and pipe to wall.
- Available with a polished or satin finish.
- Angled only. Not suitable for dual fuel.



- Prices shown are ex VAT.
- Satin finish is available. Please add 30% to the price shown.
- When ordering satin valves, please add S to the product code.

5 YEAR GUARANTEE



# VALVES - Pipes from Wall

ALL VALVES COME AS A PAIR

## SOLAR ANGLED VALVES - £79.95

PRODUCT CODE: VWS

- Manufactured from Chrome Plated brass in Italy to exacting standards.
- Available with a polished or satin finish.



## ANGLED TRVS - £94.95

PRODUCT CODE: VWATRV

- Thermostatic valve.
- Manufactured from Chrome Plated brass in Italy to exacting standards.
- Available in polished or satin finish.



## SQUARE ANGLED VALVES - £89.95

PRODUCT CODE: VWSQ

- Manufactured from Chrome Plated brass in Italy to exacting standards.
- Available with a polished or satin finish.

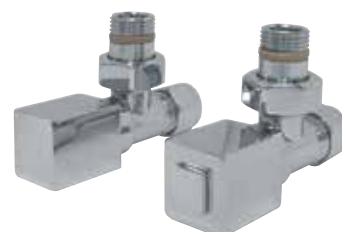

## BRUNSWICK ANGLED VALVES - £189.95

PRODUCT CODE: VWB

- Manufactured from Chrome Plated brass in Italy to exacting standards with square shroud covering connections to rail and pipe to wall.
- Available with a polished or satin finish.



- 
- Prices shown are ex VAT.
  - Satin finish is available. Please add 30% to the price shown.
  - When ordering satin valves, please add S to the product code.
- 

5 YEAR GUARANTEE

# DUAL FUEL - Dual Fuel Valves

- These new type valves eliminate the need for a T-Piece. Ideal for applications requiring symmetrical pipe centres with dual fuel kits.
- Can be used with all JIS elements.
- Only for use with pipes from the wall.



## STANDARD DUAL FUEL VALVES - £109.95

PRODUCT CODE: VWDF

- Manufactured from Chrome Plated brass in Italy to exacting standards.
- Element NOT included.



## TRV DUAL FUEL VALVES - £169.95

PRODUCT CODE: VWDFTRV

- Thermostatic Valves.
- Manufactured from Chrome Plated brass in Italy to exacting standards.
- Element NOT included.



## SQUARE DUAL FUEL VALVES - £249.95

PRODUCT CODE: VWSQDF

- Manufactured from Chrome Plated brass in Italy to exacting standards.
- Can be used with all JIS elements (element not included)



- Prices shown are ex VAT.
- Satin finish is available. Please add 30% to the price shown.
- When ordering satin valves, please add S to the product code.
- Valves are guaranteed for 5 years.

## ELEMENTS

- In addition to the Dual Fuel Valves an element is required.
- Select either a standard element, a standard square or a cylindrical adjustable element.
- See page 90 for a full description on our elements.
- Elements are guaranteed for 12 months and are available in satin at no extra cost.
- All prices ex VAT.



### STANDARD - £56.95

PRODUCT CODE: STANELEM

- IP55 RATED
- Available in the following wattages: 70w, 100w, 150w, 200w, 250w, 300w, 500w.



### STANDARD SQUARE - £84.95

PRODUCT CODE: SSE

- IP55 RATED
- Available in the following wattages: 70w, 100w, 150w, 200w, 250w, 300w, 500w.



### CYLINDRICAL ADJUSTABLE - £157.95

PRODUCT CODE: CYLELE

- IP55 RATED
- Available in the following wattages: 200w, 400w, 600w.

# DUAL FUEL - Dual Fuel Kits

- Dual Fuel Kits allow you to heat your towel rail electrically when your central heating is turned off. Dual Fuel Kits are comprised of an electric element and a chrome plated t-piece. This allows the element and central heating valve to be connected to one side.
- Note: Valves need to be ordered separately.

## STANDARD DUAL FUEL KIT - £66.95

PRODUCT CODE: SDFEKP

- Valves NOT included.
- Black dual fuel kit available at £76.95 + VAT.  
Standard element with Black T-Piece



## CYLINDRICAL ADJUSTABLE DUAL FUEL KIT - £167.95

PRODUCT CODE: CYLDFK

- Valves NOT included.



## SQUARE DUAL FUEL KIT - £76.90

PRODUCT CODE: SQDFK

- Valves NOT included.
- Comes with a Standard Element & Square T-Piece.



- Prices shown are ex VAT.
- When ordering D/F kits please specify the dimensions of the rail or wattage you require.
- Satin finish is available to order at no extra cost.
- Left hand dual fuel is available on request.
- See page 90 for a full description on our elements.
- Elements are guaranteed for 12 months.

## MIXED VALVES

- Mixed Valves - for use on Dual Fuel - pipes from the floor only. Highest quality chrome plated brass valves. Available with a polished or satin finish (please add 30% to the price shown for satin finish). Shown below with a standard dual fuel kit (not included).
- All prices ex VAT.



### MIXED SOLAR VALVES - £79.95

PRODUCT CODE: VMS

- Solar Square mixed valves - £89.95 + VAT
- Brunswick mixed valves - £189.95 + VAT



### MIXED TRV VALVES - £94.95

PRODUCT CODE: VMTRV

# ELECTRIC ONLY TOWEL RAILS

- All of the Sussex Range are available as electric only models.
- As standard, all elements are fitted on the right hand side of the towel rail.
- Left hand elements are available on request (excluding Fletching model).
- For the recommended element wattages for our rails, please see pages 94 and 95.
- All of our elements come with a minimum of one metre fitted flex.
- Prices shown are ex VAT.
- Satin finish is available at no extra cost.
- Elements are guaranteed for 12 months.
- Cable covers can be found on page 91.
- For special requirements, i.e restricted temperature elements and class II elements, please call 01825 722988 for more details.

## ELECTRIC ONLY OPTIONS

### STANDARD ELECTRIC OPTION - £89.95 - ENERGY SAVING

- The standard JIS element is constructed from 100% stainless steel. It is IP55 rated and is designed to be minimal in appearance. This element also has a built-in thermostat which automatically prevents the towel rail from becoming too hot and saves on running costs.
- PRODUCT CODE: Add EO to the rail you are ordering.



### CYLINDRICAL ADJUSTABLE ELECTRIC OPTION - £159.95 - ENERGY SAVING

- Our cylindrical adjustable element is IP55 rated and is constructed from 100% stainless steel. Designed to be minimal in appearance, the cylindrical option has four different heat settings with discreet built in LEDs indicating the current heat setting.
- Note: This element can be switched off by using the dial.
- PRODUCT CODE: Add CEO to the rail you are ordering.



### STANDARD SQUARE ELECTRIC OPTION - £102.95 - ENERGY SAVING

- The standard square electric element is IP55 rated and is constructed from 100% stainless steel. This element has a built in thermostat which automatically prevents the towel rail from becoming too hot and saves on running costs.
- PRODUCT CODE: Add SE to the rail you are ordering.



# BRACKETS & ACCESSORIES

## STANDARD ELEMENT CABLE COVER - £39.95

PRODUCT CODE: AECC

- Perfect for when you do not want a visible element cable.
- For use with standard element only.
- Please note: If using short brackets - pipe will need to be shortened or sunk into the wall.
- Satin finish is also available. please add 30% to the price shown.
- **Black Finish is also available at £38.90, see page 84 .**



## SQUARE ELEMENT CABLE COVER - £44.95

PRODUCT CODE: ASQECC

- Perfect for use when you do not want a visible cable.
- Perfect for use with any square rail (e.g. Brunswick or Hickstead).
- For use with standard element only.
- Satin finish is also available at no extra cost.



## CYLINDRICAL ELEMENT CABLE COVER - £29.95\*

PRODUCT CODE: ACYECC

- Perfect for when you do not want a visible element cable.  
\*Only suitable for the cylindrical adjustable element.
- Not suitable for the Fletching.
- Depth of element cable cover is 85mm as standard.
- A shorter version is also available (60mm).
- Satin finish is also available. please add 30% to the price shown.



## ADDITIONAL SHELF HANGER ACCESSORY

PRODUCT CODE: HAN400, HAN520, HAN620

- 100% stainless steel, can be retro fitted to the following JIS rails:  
Ouse 400, 520 & 620, Ashdown 400, 520 & 620, Beacon 400, 520 & 620,  
Steyning 400, 520 & 620 and Buxted.
- Projection 200mm.
- £79.95 - 400mm (satin finish available - 30% extra).
- £84.95 - 520mm (satin finish available - 30% extra).
- £89.95 - 620mm (satin finish available - 30% extra)



- Prices ex VAT.

# BRACKETS & ACCESSORIES

## STANDARD BRACKETS - 85mm

PRODUCT CODE: B85

- Creates overall projection of 117mm
- Standard brackets are available for all rails except the Brunswick, Arun, Hove, Fletching, Mayfield, Hickstead, Goodwood, Rye and Midhurst.
- Standard brackets are included with the towel rail unless otherwise stated.
- No extra charge for standard brackets when ordered with rail.
- **£49.95** when ordered separately.
- Standard brackets are also available in Black Finish.



## SHORT BRACKETS - 60mm

PRODUCT CODE: B60

- Creates overall projection of 92mm.
- Short brackets are available for all rails except the Brunswick, Arun, Hove, Fletching, Mayfield, Hickstead, Goodwood, Rye and Midhurst.
- Please state short brackets at the time of ordering.
- No extra charge for short brackets when ordered with rail.
- **£49.95** when ordered separately.
- Short brackets are also available in Black Finish.



## ADJUSTABLE BRACKETS - 60mm - 85mm

PRODUCT CODE: BADJ

- Available as an optional extra. Adjustable brackets are available for all rails except the Brunswick, Arun, Hove, Fletching, Mayfield, Hickstead, Goodwood, Rye and Midhurst.
- This bracket is the perfect solution for applications such as 1/2 tiled walls where you need varying bracket lengths.
- Please state adjustable brackets at the time of ordering.
- **£29.95** when ordered with the rail.
- **£79.90** when ordered separately.



- Prices shown are ex VAT.
- Satin finish is available to order at no extra cost, please add S to the product code when ordering.
- The brackets are positioned on the vertical uprights of the rail and not the horizontal bars thereby making the whole width available to hang towels.

# BRACKETS & ACCESSORIES

## CHROME PIPE KIT - £24.95

PRODUCT CODE: ACPK

- 15mm copper pipe chrome plated with round shrouds. Ideal for applications where you do not want copper pipe work exposed. (Please note, not suitable for the Goodwood or Hickstead rails).
- Satin finish is available. Please add 30% to the above price.



## SQUARE CHROME PIPE KIT - £29.95

PRODUCT CODE: ASQPK

- 15mm copper pipe chrome plated with square shrouds. Ideal for applications where you do not want copper pipe work exposed.
- Satin finish is available. Please add 30% to the above price.
- Not suitable for the Goodwood or Hickstead models



## AUTO BLEED VALVES - £11.95

PRODUCT CODE: AABV

- Expelling air from the system increases the efficiency of the heating system.
- Please note, our Auto Bleed Valves are not compatible with our Fletching range.



## STAINLESS STEEL AFTERCARE - £9.95

PRODUCT CODE: ASSA

- Specific Stainless Steel Polish developed specifically for Stainless Steel Maintenance.
- Ideal for removing minor scratches, imperfections & blemishes from our stainless steel rails.
- For use with polished rails only.



- 
- Prices shown are ex VAT.
-

# TECHNICAL INFORMATION

Model	Height (mm)	Width (mm)	Pipe centres (mm)	Pipe centre from the wall* (mm)	Projection (mm)*	Heat Output C/H format		Bracket position (mm)			Weight Kg	Elements	
						BTU	Watts	Centres	from top	from bottom		Standard	Cylindrical Adjustable
Ouse 300	700	300	270	102	117 *	1068	313	270	120	110	4.10	100w	200w
Ouse 400	700	400	370	102	117 *	1380	404	370	120	110	4.72	100w	200w
Ouse 520	700	520	490	102	117 *	1500	440	490	120	110	6.28	150w	200w
Ouse 620	700	620	590	102	117 *	1648	483	590	120	110	6.56	150w	200w
Camber 400 Curved Front	700	400	370	102	140 *	1449	425	370	120	110	4.90	150w	200w
Camber 520 Curved Front	700	520	490	102	165 *	1572	460	490	120	110	5.86	150w	200w
Camber 620 Curved Front	700	620	590	102	165 *	1763	517	590	120	110	6.66	150w	200w
Ashdown 300	1250	300	270	102	117 *	2106	617	270	120	110	6.66	200w	200w
Ashdown 400	1250	400	370	102	117 *	2368	694	370	120	110	7.68	200w	400w
Ashdown 520	1250	520	490	102	117 *	2500	733	490	120	110	9.20	200w	400w
Ashdown 620	1250	620	590	102	117 *	2726	799	590	120	110	10.50	250w	400w
Findon	1210	540	510	102	195	2654	778	510	190	110	11.54	250w	400w
Adur 400 Curved Front	1250	400	370	102	140 *	2486	728	370	120	110	7.64	200w	400w
Adur 520 Curved Front	1250	520	490	102	165 *	2597	761	490	120	110	9.68	250w	400w
Adur 620 Curved Front	1250	620	590	102	165 *	2841	832	590	120	110	10.68	250w	400w
Newick 750	600	750	720	102	117 *	1676	491	720	120	110	6.78	150w	200w
Newick 1000	600	1000	970	102	117 *	1885	552	970	120	110	8.12	200w	200w
Newick 1200	600	1200	1170	102	117 *	2079	609	1170	120	110	9.86	200w	200w
Beacon 400	1650	400	370	102	117 *	2709	794	370	120	110	10.32	300w	400w
Beacon 520	1650	520	490	102	117 *	2932	859	490	120	110	12.19	300w	600w
Beacon 620	1650	620	590	102	117 *	3129	917	590	120	110	13.78	300w	600w
Coombe	780	500	470	102	117 *	1998	585	470	120	110	7.46	200w	200w
Ansty	1191	600	570	102	117 *	2859	838	570	120	110	12.84	300w	400w
Buxted	370	520	490	102	117 *	840	246	490	60	60	3.70	100w	200w
Cinder	370	520	490	102	117 *	410	120	490	120	110	2.50	70w	200w
Rusper	700	520	490	102	117 *	740	217	490	120	110	3.76	100w	200w
Pevensey	975	520	490	102	117*	1381	405	490	110	100	5.32	150w	200w
Lindfield	1275	520	490	102	117*	1726	506	490	120	110	6.56	200w	200w
Ardingly	1580	520	490	102	117*	2114	617	490	120	110	7.78	250w	400w
Newhaven	480	520	490	77	360	1498	439	490	160	70	6.08	150w	200w
Alfriston 1260/520	1260	520	480	102	117 *	2051	601	490	120	115	7.38	200w	400w
Alfriston 650/520	650	520	480	102	117 *	1060	311	490	120	130	4.72	150w	200w
Alfriston 650/1000	650	1000	960	102	117 *	1389	407	970	120	130	6.54	150w	200w
Lewes 1400	1400	520	490	102	117 *	2109	618	490	120	110	7.72	200w	200w
Lewes 980	980	520	490	102	117 *	1533	449	490	120	110	5.90	150w	200w
Lewes 560	560	520	490	102	117 *	938	275	490	120	110	3.96	100w	200w



# TECHNICAL INFORMATION

Model	Height (mm)	Width (mm)	Pipe centres (mm)	Pipe centre from the wall* (mm)	Projection (mm)*	Heat Output C/H format		Bracket position (mm)			Weight Kg	Elements	
						BTU	Watts	Centres	from top	from bottom		Standard	Cylindrical Adjustable
Steining 300	1000	300	270	102	117*	1517	445	270	120	110	5.34	200w	200w
Steining 400	1000	400	370	102	117 *	1806	529	370	120	110	6.20	200w	200w
Steining 520	1000	520	490	102	117*	1968	576	490	120	110	7.52	200w	200w
Steining 620	1000	620	590	102	117 *	2108	618	590	120	110	8.60	200w	200w
Brunswick 1250/350	1250	350	320	56-82	70-95	1398	410	320	65	65	6.80	200w	200w
Brunswick 1650/350	1650	350	320	56-82	70-95	1838	539	320	25	25	8.72	200w	400w
Brunswick 1250/520	1250	520	490	56-82	70-95	1638	480	490	64	64	7.46	200w	200w
Brunswick 1650/520	1650	520	490	56-82	70-95	2162	633	490	25	25	10.28	250w	400w
Brunswick 900/520	900	520	490	56-82	70-95	1290	378	490	50	50	6.14	150w	200w
Brunswick 900/350	900	350	320	56-82	70-95	1111	326	350	50	50	4.88	150w	200w
Fletching 635	635	520	Side entry	50	150	1020	299	460	40	40	6.00	100w	200w
Fletching 910	910	520	Side entry	50	150	1431	420	460	40	40	7.74	150w	200w
Fletching 1185	1185	520	Side entry	50	150	1963	576	460	40	40	9.30	200w	400w
Fletching - Floor to Wall	1200	520	Side entry	120	150	1858	544	460	40	0	8.28	200w	N/A
Hickstead 1010	1010	500	52	56-82	100-125	1291	378	52	100	100	7.42	200w	200w
Hickstead 1400	1400	500	52	56-82	100-125	1722	505	52	100	100	10.04	200w	200w
Goodwood 1010	1010	500	52	56-82	95 - 120	1489	436	52	100	100	7.94	200w	200w
Goodwood 1400	1400	500	52	56-82	95 - 120	1986	582	52	100	100	10.40	200w	200w
Rye	1800	520	Side entry	165	190	1878	550	Top: 315 Bottom: 430	450	450	7.60	200w	N/A
Midhurst	1765	550	Side entry	N/A	560	3345	980	N/A	95	245	13.98	300w	N/A
Hove 1460/360	1460	360	300	55	75	2406	705	Variable			9.60	300w	400w
Hove 1460/530	1460	530	470	55	75	2785	816	Variable			14.40	300w	600w
Hove 1460/710	1460	710	650	55	75	3498	1025	Variable			17.90	500w	600w
Hove 1660/360	1660	360	300	55	75	2944	863	Variable			10.64	300w	400w
Hove 1660/530	1660	530	470	55	75	3408	999	Variable			15.70	500w	600w
Arun 1460/275	1460	275	215	65	80	2154	631	175	85	0	14.04	300w	400w
Arun 1460/360	1460	360	300	65	80	2839	832	260	85	0	15.44	300w	400w
Arun 1460/535	1460	535	475	65	80	3676	1077	435	85	0	22.80	500w	600w
Arun 1960/275	1960	275	215	65	80	2805	822	175	85	0	16.46	500w	600w
Arun 1960/360	1960	360	300	65	80	3715	1088	260	85	0	21.02	500w	600w
Arun 1960/535	1960	535	475	65	80	4210	1234	435	85	0	29.80	500w	600w
Mayfield 320	1010	320	950 (Horizontal)	55 - 75	140 - 160	2689	788	165	25	25	12.26	N/A	N/A
Mayfield 470	1010	470	950 (Horizontal)	55 - 75	140 - 160	3760	1102	320	30	25	17.80	N/A	N/A

\* Standard brackets measurement, shortened brackets available to reduce projection/centres by 25.

Not applicable for Arun, Hove, Mayfield, Fletching, Goodwood, Hickstead, Brunswick, Newhaven, Rye, Midhurst or Findon

Heat output figures are for central heating versions. BTU/Watt figures are based on  $\Delta T=60K$ .

All towel rails are manufactured from 100% Stainless Steel and can be used on all systems including open/hot water systems.

JIS Europe Ltd, Unit 2 Oak Ferrars Industrial Estate, Piltown, Uckfield TN22 3XR

Tel: +44 (0) 1825 722988 Fax +44 (0)1825 722854 Email: info@jiseurope.co.uk www.sussexrange.co.uk



Beacon 520



JIS Europe Ltd, Unit 2 Oak Ferrars Industrial Estate, Piltdown, Uckfield TN22 3XR  
Tel: +44 (0) 1825 722988 Fax +44 (0)1825 722854 Email: [info@jiseurope.co.uk](mailto:info@jiseurope.co.uk) [www.sussexrange.co.uk](http://www.sussexrange.co.uk)

# SUSSEX RANGE

by JIS EUROPE

HEATED TOWEL RAILS

EST 1997

100% STAINLESS STEEL